

Video-inserter CI-RL1-RLK

Compatible with
Dacia, Fiat, Smart and Renault vehicles
with RLink or MediaNav system
and **Opel** vehicles with Navi 50 or Navi 80



Video-inserter with 2 video inputs and rear-view camera input

Product features

- Video-inserter for factory-infotainment systems
- 2 video-inputs for after-market devices (e.g. DVD-Player, DVB-T tuner)
- Rear-view camera video-input
- Automatic switching to rear-view camera input on engagement of the reverse gear
- Video-in-motion (ONLY for connected video-sources)
- Video-inputs NTSC compatible

Contents

1. Prior to installation

- 1.1. Delivery contents
- 1.2. Checking the Interface compatibility of vehicle and accessories
- 1.3. Boxes and connectors
 - 1.3.1. Video-interface
 - 1.3.1.1. Dip-switch settings
 - 1.3.1.2. Enabling the interface's video inputs (dip 2-3)
 - 1.3.1.3. Rear-view camera setting (dip 5)
 - 1.3.1.4. Monitor Selection (dip 6-8)

2. Installation

- 2.1. Place of installation
 - 2.1.1. Place of installation – video interface
 - 2.1.2. Place of installation – daughter PCB
- 2.2. Connection scheme
- 2.3. Connection – 6pin interface cable
- 2.4. Installation of ribbon cables into monitor panel
 - 2.4.1. 50Pin-Version (MediaNav)
 - 2.4.2. 60Pin-Version (RLink)
 - 2.4.2.1. Warning notes, concerning the installation of ribbon cables
- 2.5. Connection – video sources
 - 2.5.1.1. After-market rear-view camera
 - 2.5.2. Audio-insertion
- 2.7. Connecting - external keypad
- 2.8. Picture settings

3. Interface operation

4. Specifications

5. Frequently asked questions

Legal Information

By law, watching moving pictures while driving is prohibited, the driver must not be distracted. We do not accept any liability for material damage or personal injury resulting, directly or indirectly, from installation or operation of this product. This product should only be used while standing or to display fixed menus or rear-view-camera video when the vehicle is moving, for example the MP3 menu for DVD upgrades.

Changes/updates of the vehicle's software can cause malfunctions of the interface. We offer free software-updates for our interfaces for one year after purchase. To receive a free update, the interface must be sent in at own cost. Labour cost for and other expenses involved with the software-updates will not be refunded.

1. Prior to installation

Read the manual prior to installation.

Technical knowledge is necessary for installation. The place of installation must be free of moisture and away from heat sources.

1.1. Delivery contents

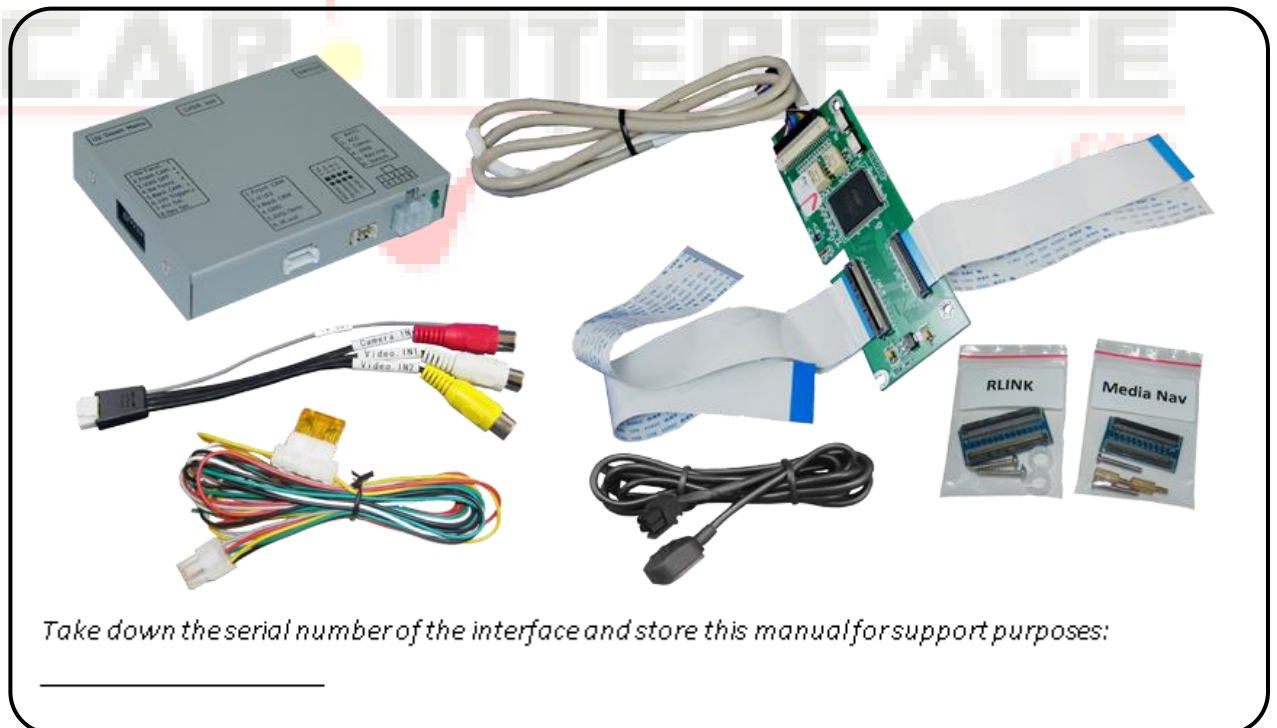

1.2. Checking the compatibility of vehicle and accessories

Requirements

Brand	Compatible vehicles	Compatible systems
Dacia	Dokker since 2013-, Duster since 2014, Lodgy since 2012, Logan since 2013, Sandero since 2012	MediaNav Vehicles with MediaNav (50-Pin) only compatible until 09/2019!
Fiat	Talento model year since 2016	MediaNav Vehicles with MediaNav (50-Pin) only compatible until 09/2019!
Opel	Movano B since about 2016 til 04/2021, Vivaro B model years 2015 til 2019	Navi 50 (MediaNav), Navi 80 IntelliLink (R-Link) Vehicles with MediaNav (50-Pin) only compatible until 09/2019!
Renault	Captur model year 2015-2019, Clio model year 2014-2019, Kangoo model year since 2014, Master model year since 2015, Megane model year 2013, Trafic model year since 2015 Zoe model year since 2013 and other vehicles with	Media Nav Vehicles with MediaNav (50-Pin) only compatible until 09/2019!
	Captur model year 2015-2016, Clio model year 2014-2016, Kangoo model year since 2014, Laguna since 2014, Master model year since 2015, Megane model year 2013-2015, Scenic about 05/2013-09/2016, Trafic model year since 2015, Twingo model year 2013-2019, Zoe model year 2013-2019 and other vehicles with	R-Link - 7inch monitor (NO SD-card slot on right side of the monitor)
Smart	ForTwo (C453/A453) since 09/2014, ForFour (W453) since 08/2014, Brabus Versions since 2016	Smart Media System (R-Link)

**Vehicles with MediaNav (50-Pin) only compatible until 09/2019!
(to be recognized by model no. LAN52xxWRx on the sticker)**

Limitations

<i>Video only</i>	The interface inserts ONLY video signals into the infotainment. For audio insertion factory-audio-AUX-input or a FM-modulator is required. If 2 audio sources shall be connected to the infotainment, an additional electronic is necessary to switch them.
<i>Factory rear-view camera</i>	Automatic switch to factory rear-view camera only while reverse gear is engaged. To delay the switch reset, additional electronics is required.
<i>Video input signal</i>	NTSC video sources compatible only.

1.3. Connectors – video interface

The video-interface converts the video signals of connected after-market sources in a factory monitor compatible picture signal which is inserted in the factory monitor, by using separate trigger options.

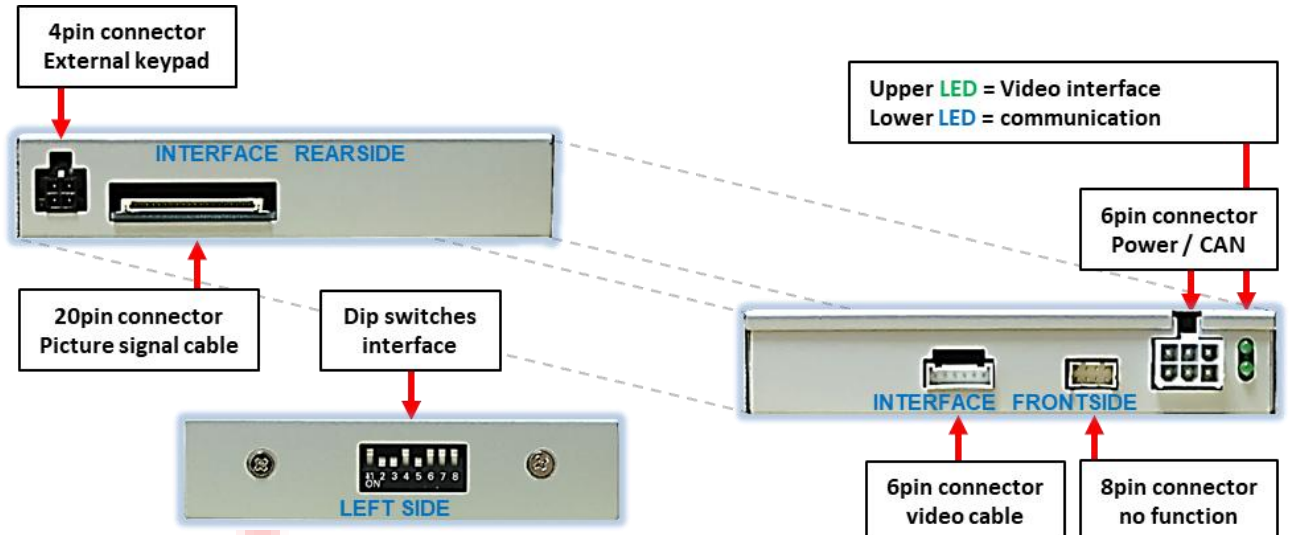

1.3.1.1. Dip-switch settings

Some settings must be selected by the dip-switches on the video-interface. Dip position down is ON and position up is OFF.



Dip	Function	ON (down)	OFF (up)
1	No function		set to OFF
2	CVBS AV1-input	enabled	disabled
3	CVBS AV2-input	enabled	disabled
4	No function		set to OFF
5	Rear-view cam type	after-market	factory or none
6	Monitor specific adjustments		set to OFF
7			
8			

See following chapters for detailed information.

After each Dip-switch-change a power-reset has to be performed!

See the following chapters for detailed information.

1.3.1.2. Enabling the interface's video inputs (dip 2-3)

Only the enabled video inputs can be accessed by switching through the interface's video sources. It is recommended to enable only the required inputs, because the disabled inputs will be skipped while switching through the video interfaces inputs.

1.3.1.3. Rear-view camera setting (dip 5)

If set to OFF, the interface switches to factory LVDS picture while the reverse gear is engaged to display factory rear-view camera or factory optical park system picture.

If set to ON, the interface switches to its rear-view camera input while the reverse gear is engaged.

1.3.1.4. Monitor selection (dip6, 7-and 8)

Set to OFF

Note: Dip 1 and 4 are out of function and have to be set to **OFF**.

2. Installation

Switch off ignition and disconnect the vehicle's battery! The interface needs a permanent 12V source. If according to factory rules disconnecting the battery is to be avoided, it is usually sufficient to put the vehicle to "Sleep-Mode". In case it does not succeed, disconnect the battery with a resistor lead.

If power source is not taken directly from the battery, the connection has to be checked for being start-up proven and permanent.

2.1. Place of installation

2.1.1. Place of installation – video interface

The interface boxes shall be installed behind the vehicle's head-unit or the glove department, depending on equipment and space.

2.1.2. Place of installation - daughter PCB

The interface's daughter PCB is prepared to be installed between the head unit's housing and the monitor panel.

For this purpose the housing of head-unit have to be opened.

2.2. Connection Scheme

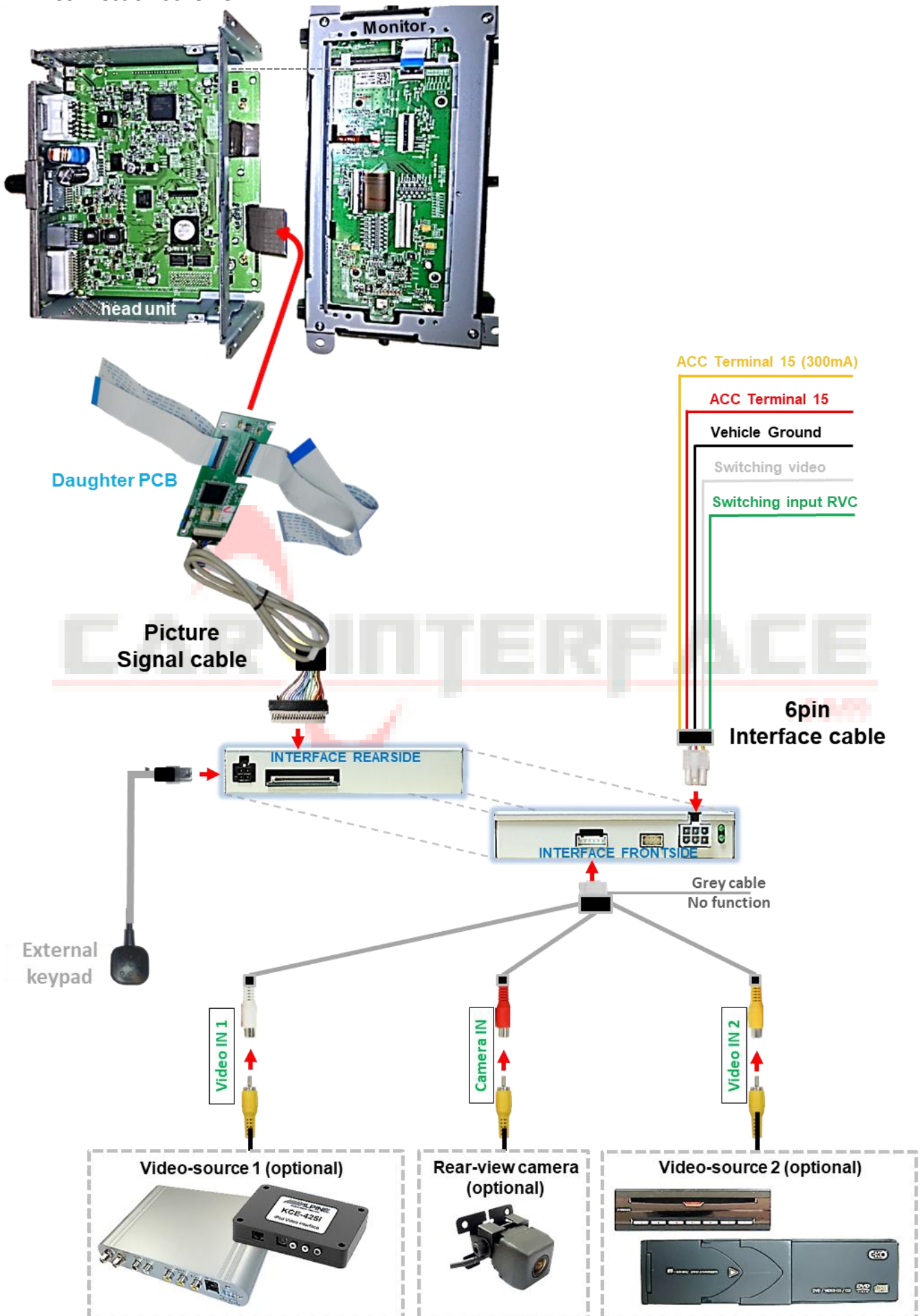

2.3. Connection – 6pin interface cable

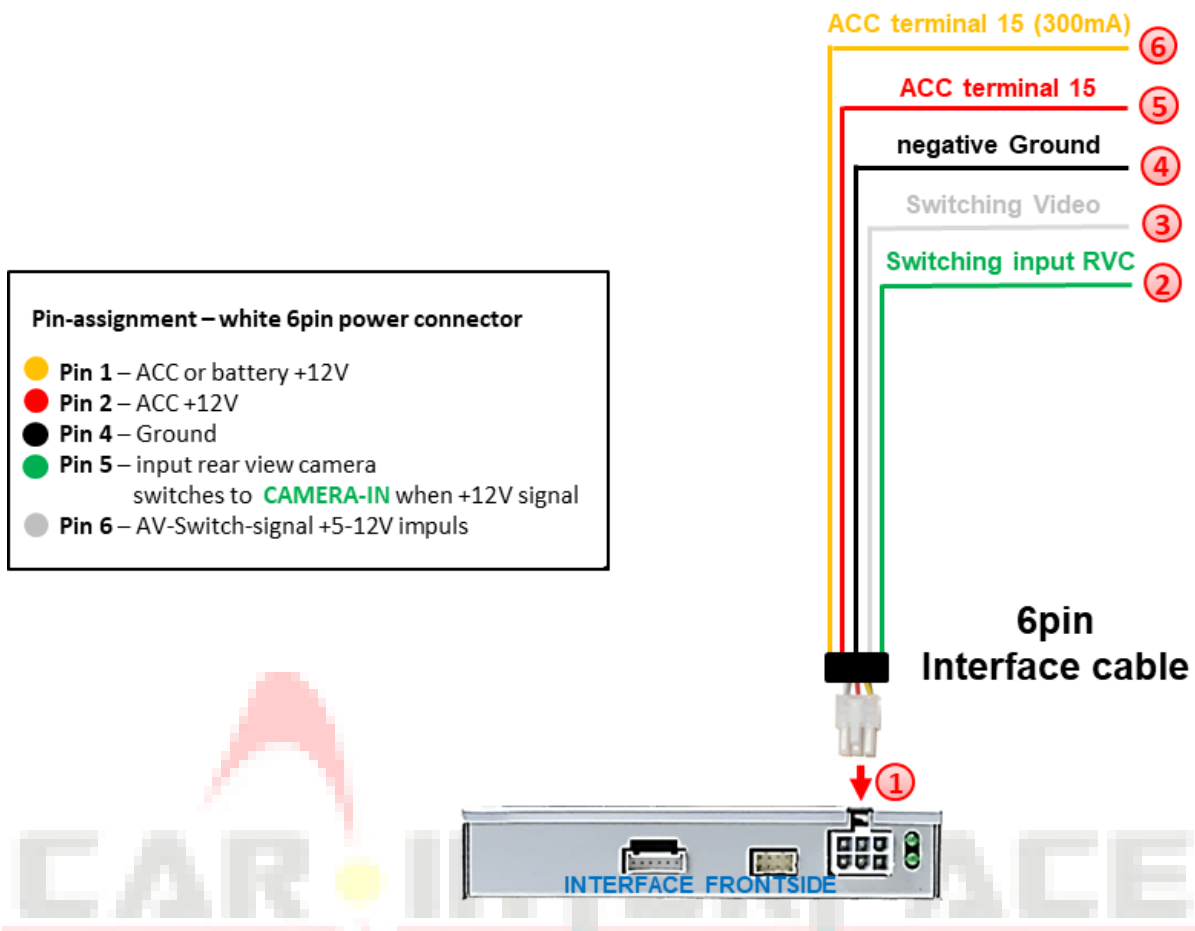

- ❶ Connect the white female 6pin connector of the 6pin interface cable to the male 6pin connector of the video interface.
- ❷ Connect the green wire of the 6pin interface cable to +12V of the reverse gear signal. (e.g. reversing light).
- ❸ If desired, the white wire of the 6pin interface cable can be used alternatively to the external button to switch the video sources (12V pulse for 2-3 seconds).
- ❹ Connect the black wire of the 6pin interface cable to vehicle ground.
- ❺ Connect the red wire of the 6pin interface cable to +12V ACC terminal 15.
- ❻ Connect the yellow wire of the 6pin interface cable to +12V ACC (300mA).

Note: The connection of the green wire (Reverse signal) will be described in chapter “After-market rear-view camera”. The white wire, can be used by +12V impulse to switch the enabled video sources , same as the keypad (see chapter “video interface-operation”).

2.4. Installation - Ribbon cables into the Monitor panel

Remove the factory monitor and open it's housing. The external daughter PCB is built to be installed into the optical lead between the monitor panel and mainboard of the vehicles monitor. The daughter PCB is equipped with two different ribbon cable options to support two different monitor systems. Both 50pin Ribbon cables and both 60pin Ribbon cables are easily recognizable, as they differ in size. Depending on the system, the two unneeded ribbon cables have to be removed by unclipping the Ribbon cable base.

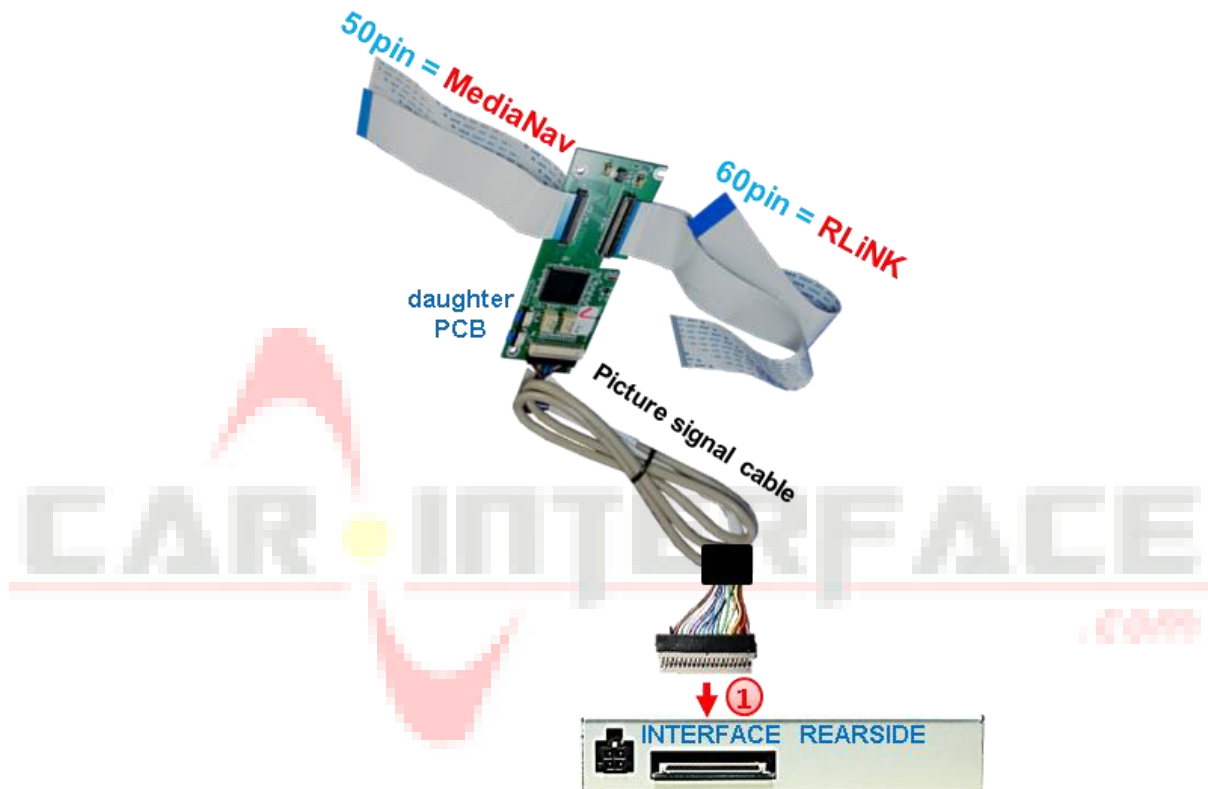

- 1 Connect the female 20pin connector of the daughter PCB to the male 20pin connector of the picture signal cable and connect the second male 20pin connector opposite the cable to the female 20pin connector of the interface. Take care for installing the cable in the right direction as both connectors seem to be identical. (Take notice of the wire's caption "MONITOR SIDE" and "BOX SIDE")

2.4.1. Media Nav with 50pin Ribbon cable

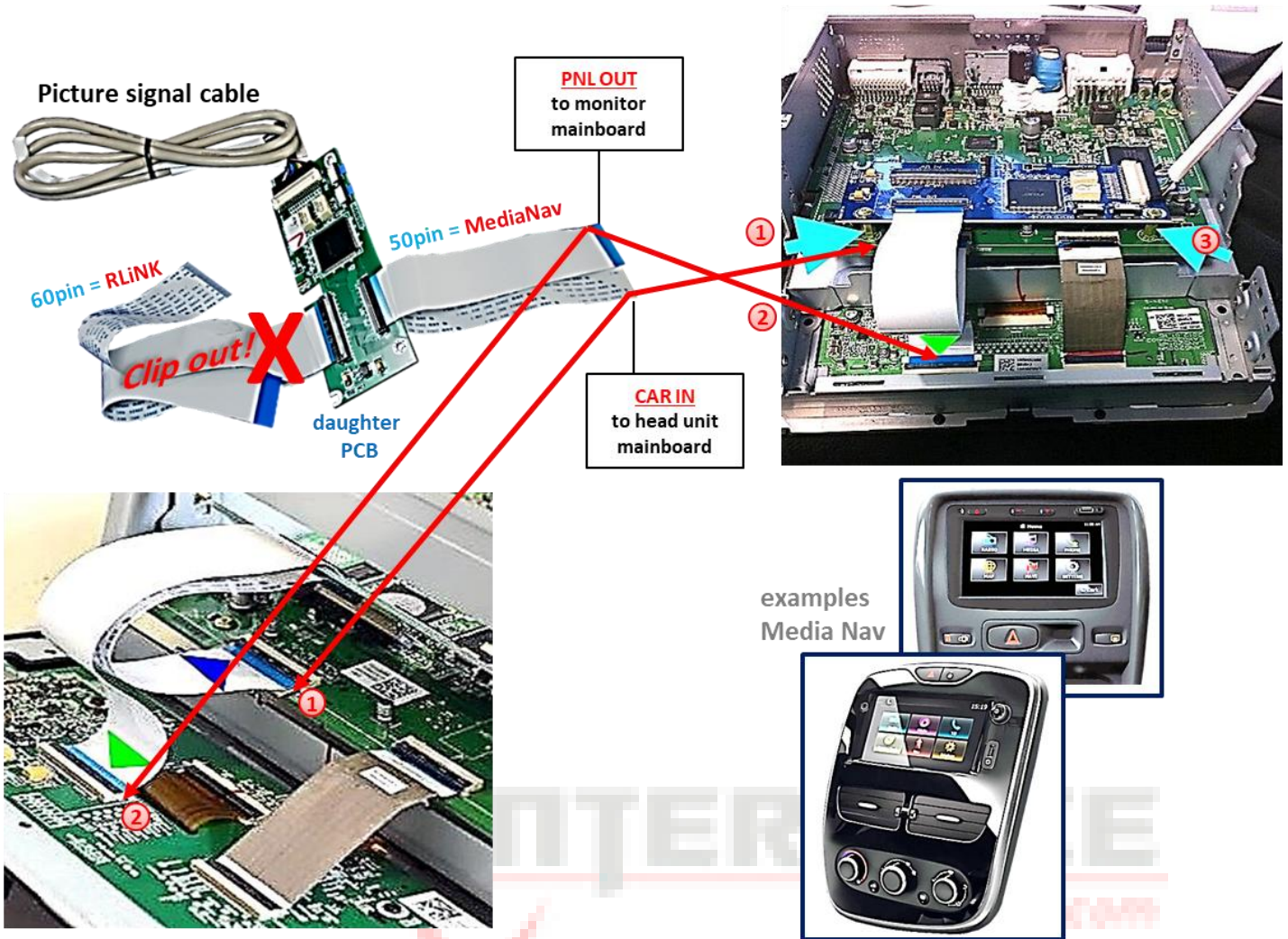

- ① Disconnect the optical leads housed between the monitor's mainboard and the monitor-panel. Connect the daughter PCB's ribbon cable **CAR-IN** to the ribbon cable base of the monitor's mainboard. For this procedure you may either use the original ribbon cable or the ribbon cable of the daughter PCB. Make sure that the connector pins of each pin connector are faced to the platinum before clipping them.
- ② Connect the ribbon cable **PNL OUT** of the daughter PCB to the ribbon cable base of the monitor's platinum (take care again for a platinum faced installation of the connector pins!)
- ③ Carefully fix the daughter PCB to the mainboard of the monitor by using the enclosed spacers and screws

2.4.2.1. Warning notes, concerning the installation of ribbon cables:

- 1) The contacting ends of ribbon cables always have to be installed in a straight and precise 180° position to the connector. Each deviation from a perfect contact position will cause faulty contact and even danger of short circuit
- 2) The ribbon cable's contacting side always has to correspond to the contacting side of the connector, concerning the mounting position.

2.4.2. R-Link with 60pin Flex cable

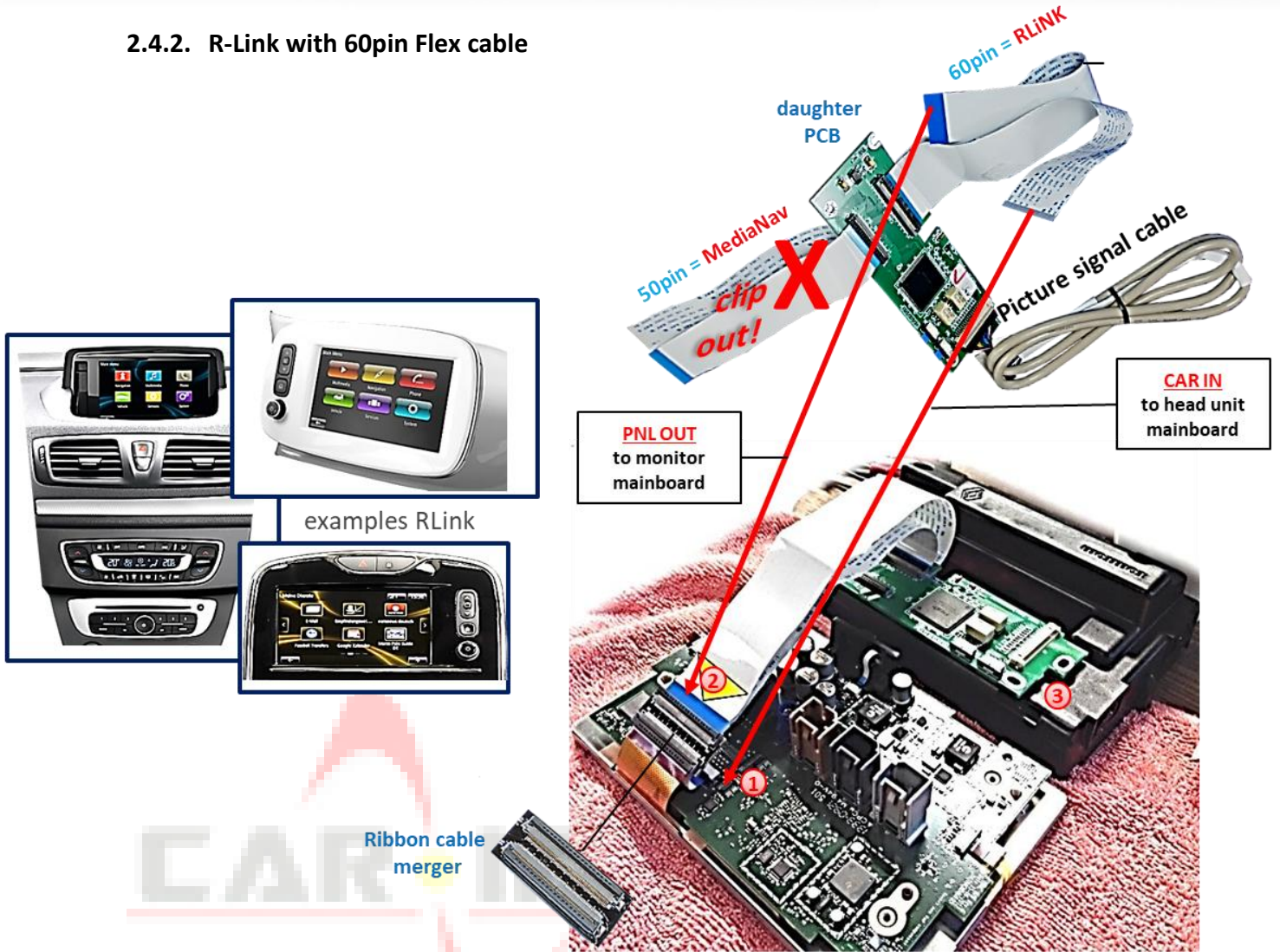

① Remove the Ribbon cable between the monitor's monitor panel and the monitor PCB. Connect the daughter PCB's ribbon cable **CAR-IN** to the ribbon cable base of the main PCB. For this procedure you may either use the original ribbon cable or the ribbon cable of daughter PCB. Make sure that the connector pins of each pin connector are faced to the platinum before clipping them.

② Connect the daughter PCB's ribbon cable **PNL OUT** to the ribbon cable base of the monitor panel's short original Flex cable, by using the enclosed Ribbon cable merger (pay same attention to platinum faced installation of the connector pins!).

③ Carefully fix the daughter PCB to the monitor part by using the enclosed longer screws and plastic spacers.



Attention: The plastic washers must be installed under the PCB, otherwise the length of the screws may cause destruction inside the monitor!

The picture on the right side shows the position for leading out the out the ribbon cables

Note: Please observe above warning notes for ribbon cable installation!

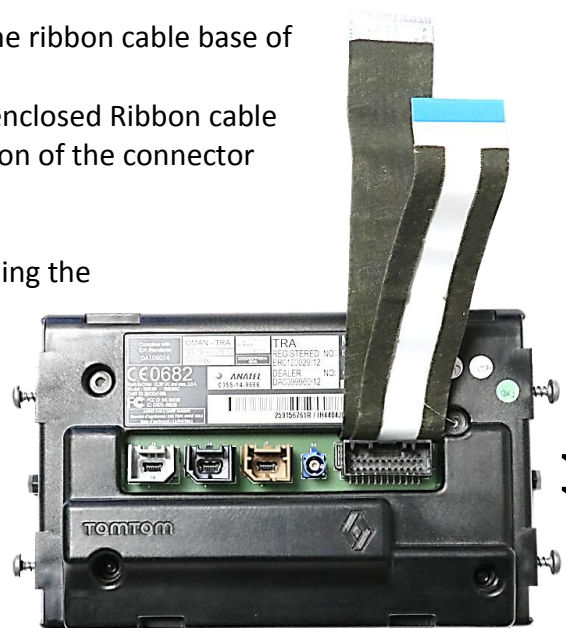

2.5. Connection - video sources

It is possible to connect two after-market video sources and one after-market rear-view camera to the video-interface.

Before final installation of the peripheral devices, we recommend a test-run to detect a incompatibility of vehicle and interface. Due to changes in the production of the vehicle manufacturer there's always a possibility of incompatibility.

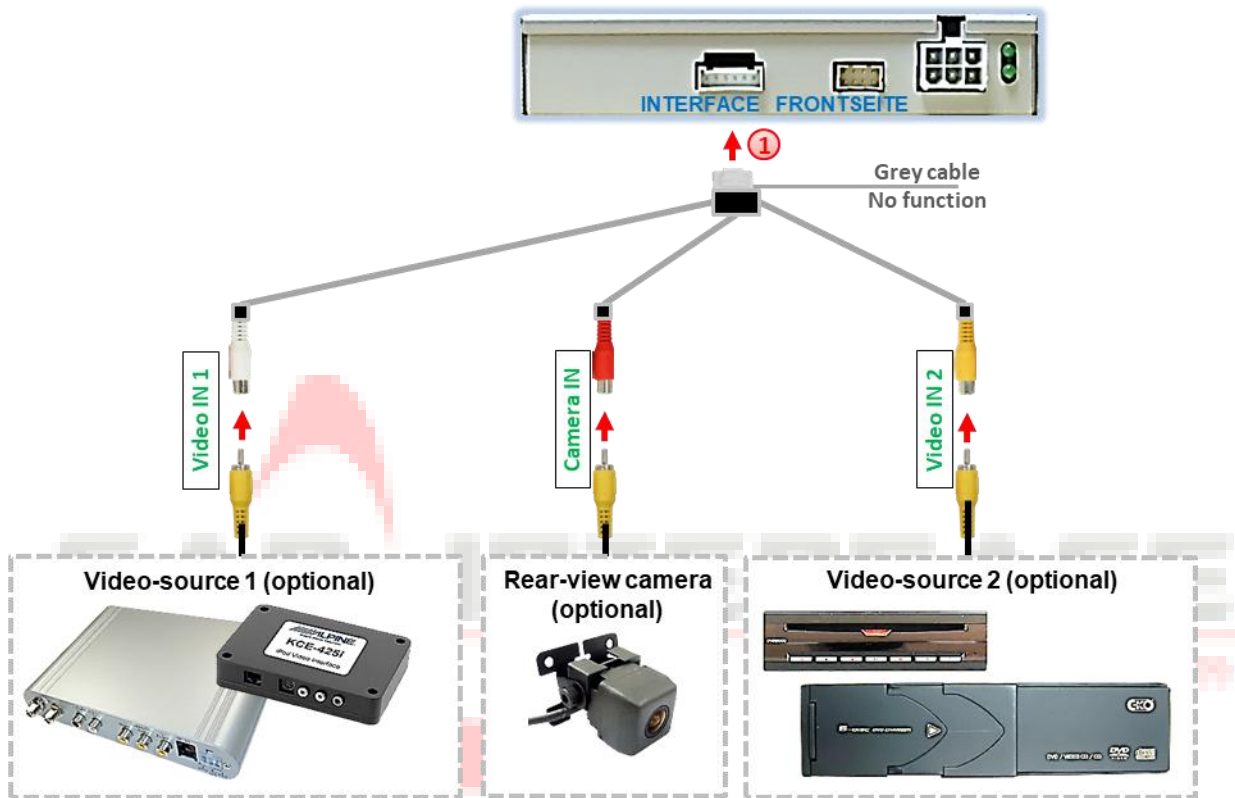

- 1 Connect the 6pin connector of the video cable to the 6pin connector of the video interface.
- 2 Connect the rear-view camera's RCA to the female RCA „**Camera IN**“ of the video cable.

Note: The picture settings for CAM input have to be adjusted in AV2.

- 3 Connect the RCA of the video source 1 and video source 2 to the female RCA „**Video IN1**“ and „**Video IN2**“ of the video cable.

2.5.1. After-market rear-view camera

Note: Set dip5 of video-interface to ON.

To switch to the rear-view camera when reverse gear is engaged, an external switching signal from the reverse gear light is required. As the reverse gear light signal contains electronic interference, a traditional open relay (e.g AC-RW-1230 with wiring AC-RS5) or filter (e.g. AC-PNF-RVC) is required. Below schema shows the use of a relay (normally open).

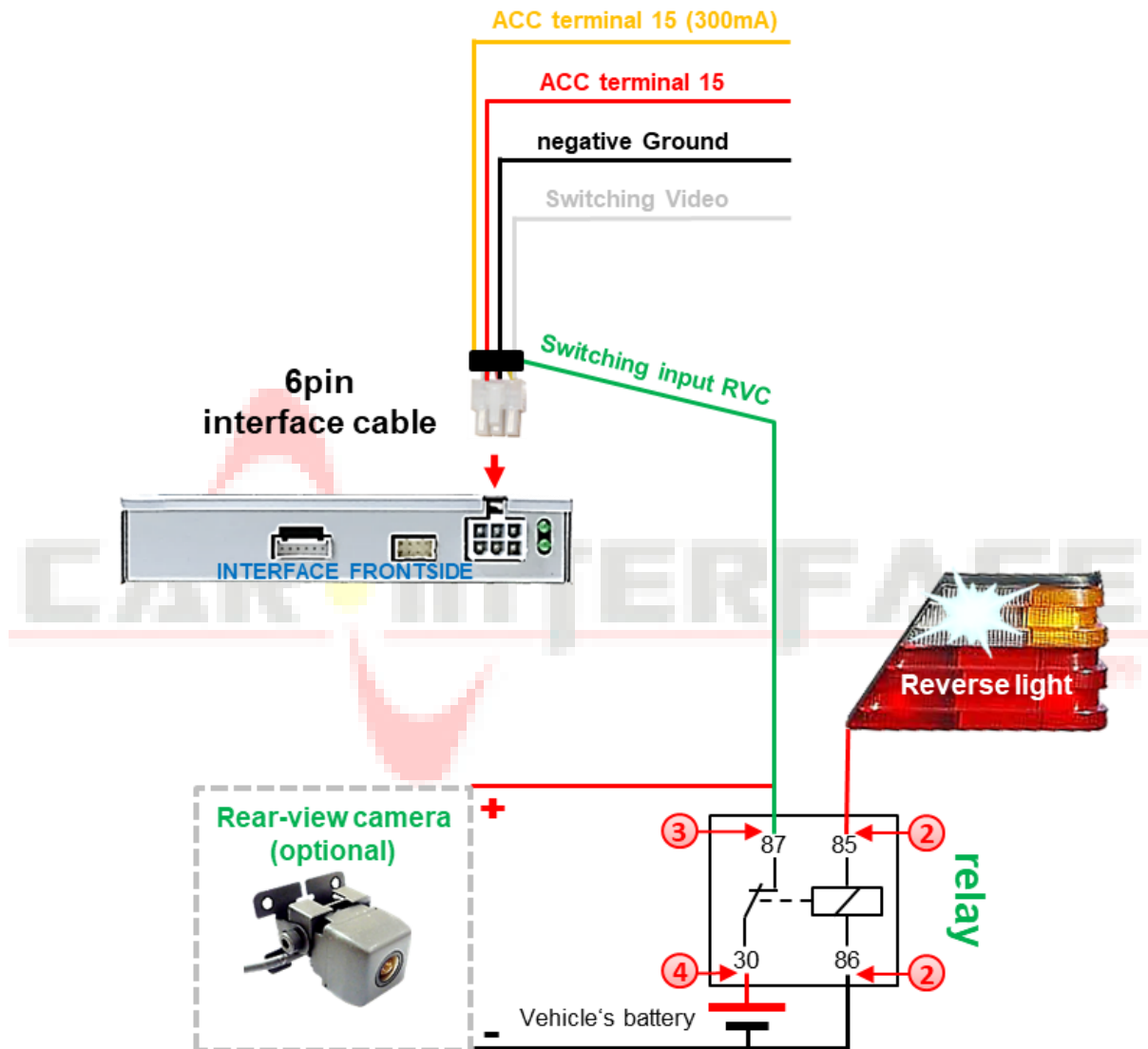

- ① Connect the green **switching input cable** to the output connector (87) of the relay.
- ② Connect the Reverse light's power-cable to coil (85) and the vehicle's ground to coil (86) of the relay.
- ③ Connect the output connector (87) of the relay to the rear-view camera's power-cable, like you did it to the green **switching input cable** before.
- ④ Connect stabile and permanent +12V to the relay's input connector (30).

2.5.2. Audio Insertion

This interface can only insert video signals into the factory infotainment. If an AV-source is connected, audio insertion must be done by factory audio AUX input or FM-modulator. The inserted video-signal can be activated simultaneously to each audio-mode of the factory infotainment.

If 2 AV sources shall be connected to the infotainment, additional electronic is necessary to switch the audio signals.

2.6. Connection – external keypad

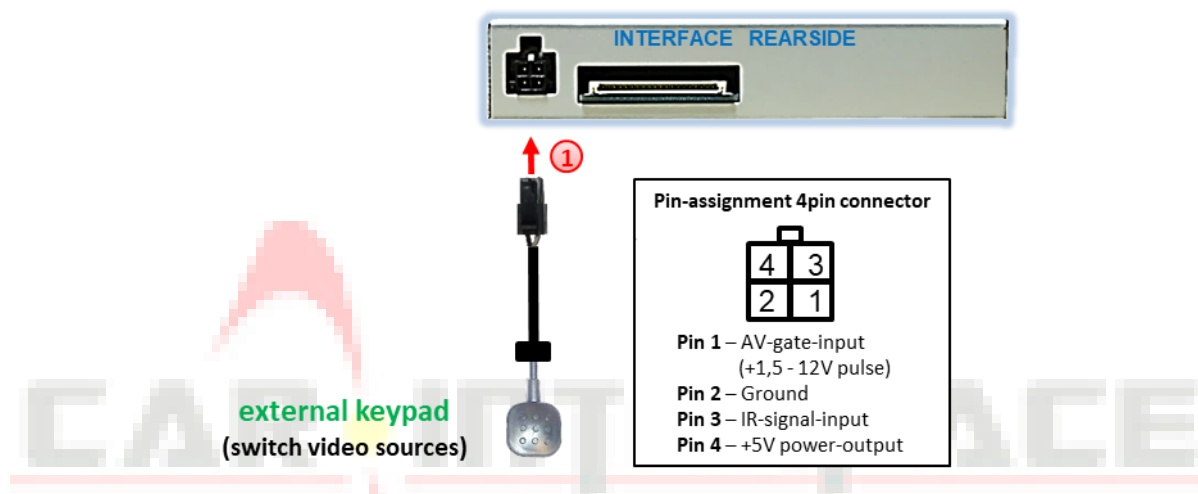

- 1 Connect the keypad's female 4pin connector to the male 4pin connector of the video-interface.

Note: Even if the switching through several video sources by the keypad mightn't be required, the keypad's invisible connection and availability is strongly recommended.

2.7. Picture settings

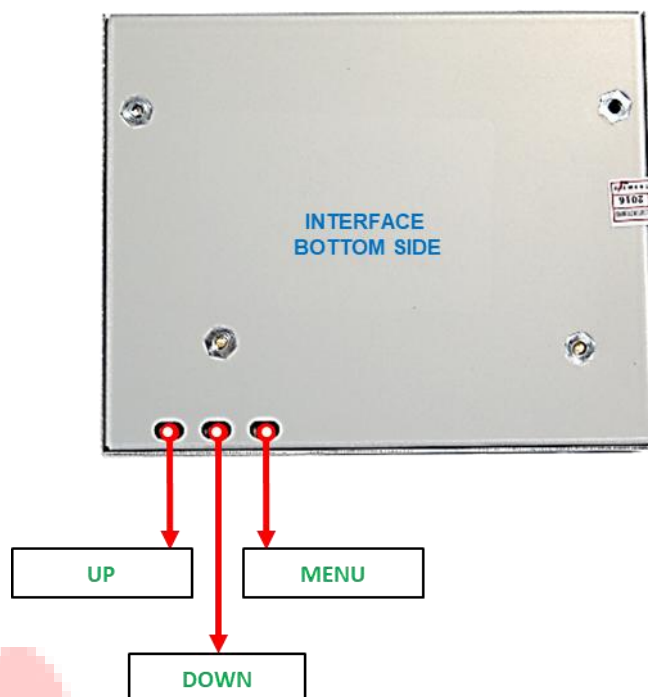

The picture settings are adjusted by the 3 buttons on the video-interface. Press the MENU button to open the OSD settings menu or to switch to the next menu item. Press UP and DOWN change the selected value. The buttons are embedded in the housing to avoid accidental changes during or after installation. Picture settings must be done separately for RGB, AV1, AV2 and CAM while the corresponding input is selected and visible on the monitor.

Note: The OSD menu is only shown when a working video source is connected to the selected video-input of the interface.

The following settings are available:

- Brightness
- Contrast
- Saturation
- Position H (horizontal)
- Position V (vertical)

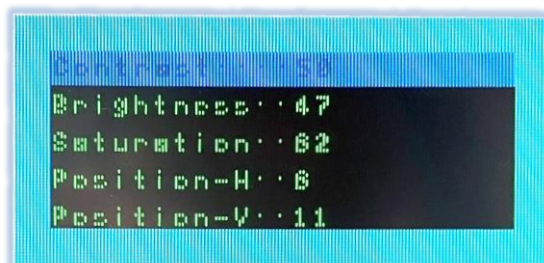

3. Interface operation

Press the interface's external keypad to switch the video source. Each repetition will switch to the next enabled input. If all inputs are enabled the order is:

Factory video → *video IN1* → *video IN2* → *factory video* →

Disabled inputs will be skipped.

Alternatively the white wire of the 6pin cable can be used with a +5-12V pulse to switch the video-sources.

Note: Even if the switching through several video sources by the keypad mightn't be required, the keypad's invisible connection and availability is strongly recommended.

4. Specifications

BATT/ACC range	7V - 25V
Stand-by power drain	20mA
Power	190mA @12V
Video input	0.7V - 1V
Video input formats	NTSC
RGB-video amplitude	0.7V with 75 Ohm impedance
Temperature range	-40°C to +85°C
Dimensions video-box	113 x 25 x 97mm (W x H x D)

5. FAQ – Trouble shooting Interface functions

For any troubles which may occur, check the following table for a solution before requesting support from your vendor.

Symptom	Reason	Possible solution
No picture/black picture (factory picture).	Not all connectors have been reconnected to factory head-unit or monitor after installation.	Connect missing connectors.
	No power on CAN-bus box (all LED CAN-bus box are off).	Check power supply of CAN-bus box. Check CAN-bus connection of CAN-bus box.
	CAN-bus box connected to CAN-bus in wrong place.	Refer to the manual where to connected to the CAN-bus. If not mentioned, try another place to connect to the CAN-bus.
	No power on video-interface (all LED video-interface are off).	Check whether CAN-bus box delivers +12V ACC on red wire output of 8pin to 6pin cable. If not cut wire and supply ACC +12V directly to video-interface.
No picture/black picture/white picture (inserted picture) but factory picture is OK.	No picture from video source.	Check on other monitor whether video source is OK.
	No video-source connected to the selected interface input.	Check settings dips 1 to 3 of video interface which inputs are activated and switch to corresponding input(s).
	LVDS cables plugged in wrong place.	Double-check whether order of LVDS cables is exactly connected according to manual. Plugging into head-unit does not work when the manual says to plug into monitor and vice versa.
Inserted picture totally wrong size or position.	Wrong monitor settings of video-interface.	Try different combinations of dips 7 and 8 of video-interface. Unplug 6pin power after each change.
Inserted picture double or 4 times on monitor.		
Inserted picture distorted, flickering or running vertically.	Video sources output set to AUTO or MULTI which causes a conflict with the interfaces auto detection.	Set video source output fixed to PAL or NTSC. It is best to set all video sources to the same standard.
	If error occurs only after source switching: Connected sources are not set to the same TV standard.	Set all video sources to the same standard.
	Some interfaces can only handle NTSC input.	Check manual whether there is a limitation to NTSC mentioned. If yes, set source fixed to NTSC output.
Inserted picture qual. bad.	Picture settings have not been adjusted.	Use the 3 buttons and the interface's OSD to adjust the picture settings for the corresponding video input.
Inserted picture size slightly wrong.		
Inserted picture position wrong.		
Camera input picture flickers.	Camera is being tested under fluorescent light which shines directly into the camera.	Test camera under natural light outside the garage.
Camera input picture is bluish.	Protection sticker not removed from camera lens.	Remove protection sticker from lens.

Symptom	Reason	Possible solution
Camera input picture black.	Camera power taken directly from reverse gear lamp.	Use relay or electronics to "clean" reverse gear lamp power. Alternatively, if CAN-bus box is compatible with the vehicle, camera power can be taken from green wire of 6pin to 8pin cable.
Camera input picture has distortion.		
Camera input picture settings cannot be adjusted.	Camera input picture settings can only be adjusted in AV2 mode.	Set dip 3 of video-interface to ON (if not input AV2 is not already activated) and connect the camera to AV2. Switch to AV2 and adjust settings. Reconnect camera to camera input and deactivate AV2 if not used for other source.
Graphics of a car in camera input picture.	Function PDC is ON in the interface OSD.	In compatible vehicles, the graphics will display the factory PDC distance. If not working or not wanted, set interface OSD menu item UI-CNTRL to ALLOFF.
Chinese signs in camera input picture	Function RET or ALL is ON (function for Asian market) in the interface OSD.	Set interface OSD menu item UI-CNTRL to ALLOFF or PDCON.
Not possible to switch video sources by OEM button.	CAN-bus interface does not support this function for vehicle.	Use external keypad or cut white wire of 6pin to 8pin cable and apply +12V impulses for AV-switching.
Not possible to switch video sources by external keypad.	Pressed too short.	For video source switching a longer press of about 2.5 seconds is required.
	SW-version of interface does not support external keypad.	Use OEM-button or cut white wire of 6pin to 8pin cable and apply +12V impulses for AV-switching.
Interface does not switch to camera input when reverse gear is engaged.	CAN-bus interface does not support this function for the vehicles.	Cut the green wire of the 6pin to 8pin cable and apply +12V constant from reverse gear-lamp signal. Use relay to "clean" R-gear lamp power.
Interface switches video-sources by itself.	CAN-bus interface compatibility to vehicle is limited.	Cut the grey wire of 6pin to 8pin and isolate both ends. If problem still occurs, additionally cut the white wire of 6pin to 8pin cable and isolate both ends.



10R-03 5384

Made in China

