

v.LOGiC Intelligent Solution Interface

CI-V5-MMI3G-PNP

**Compatible with Audi MMI3G Basic/High and
MMI3G+ High navigation systems with 4pin HSD
LVDS connector**

Product features

- Interactive lane lines
- Own on-screen display and setup
- Rear-view camera input
- Automatic switching to rear-view camera input on engagement of reverse gear from all operation modes
- Front camera input
- Manual switching to rear-view camera
- 2 trigger outputs (+12V max. 1A), separately adjustable switching events (CAN, ACC, camera, reverse gear)
- Compatible with all factory video accessories (e.g. rear-view camera, TV-tuner)
- USB update-port for software-updates by consumer



Contents

1. Prior to Installation

- 1.1. Delivery contents
- 1.2. Check compatibility of vehicle and accessories
- 1.3. Setting the dip switches of the interface-box V5C-M653
- 1.4. LED's of the interface-box V5C-M653

2. Connection schema

3. Installation

- 3.1. Connecting interface-box and harnesses
- 3.2. LVDS connection
 - 3.2.1. After-market front camera
 - 3.2.1.1. Connection to the after-market front camera
 - 3.2.1.2. Settings for connecting an after-market front camera
 - 3.2.2. After-market rear-view camera
 - 3.2.2.1. Connection to the after-market rear-view camera
 - 3.2.2.2. Settings for connecting an after-market rear-view camera
 - 3.2.2.3. Settings for OEM rear-view camera
 - 3.2.3. Configurable trigger outputs
- 3.3. Interactive lane lines
- 3.4. Picture settings

4. Operation

- 4.1. OSD – On-screen display
 - 4.1.1. OSD – Operation
 - 4.1.2. OSD – Additional setting options
- 4.2. Selecting the interface as current video source

5. Specifications

6. Connections (interface-box)

Legal Information

By law, watching moving pictures while driving is prohibited, the driver must not be distracted. We do not accept any liability for material damage or personal injury resulting, directly or indirectly, from installation or operation of this product. This product should only be used while standing or to display fixed menus or rear-view-camera video when the vehicle is moving, for example the MP3 menu for DVD upgrades.

Changes/updates of the vehicle's software can cause malfunctions of the interface. We offer free software-updates for our interfaces for one year after purchase. To receive a free update, the interface must be sent in at own cost. Labor cost for and other expenses involved with the software-updates will not be refunded.



1. Prior to installation

Read the manual prior to installation. Technical knowledge is necessary for installation. The place of installation must be free of moisture and away from heat sources.

1.1. Delivery contents

Take down the SW-version and HW-version of the interface boxes, and store this manual for support purposes.

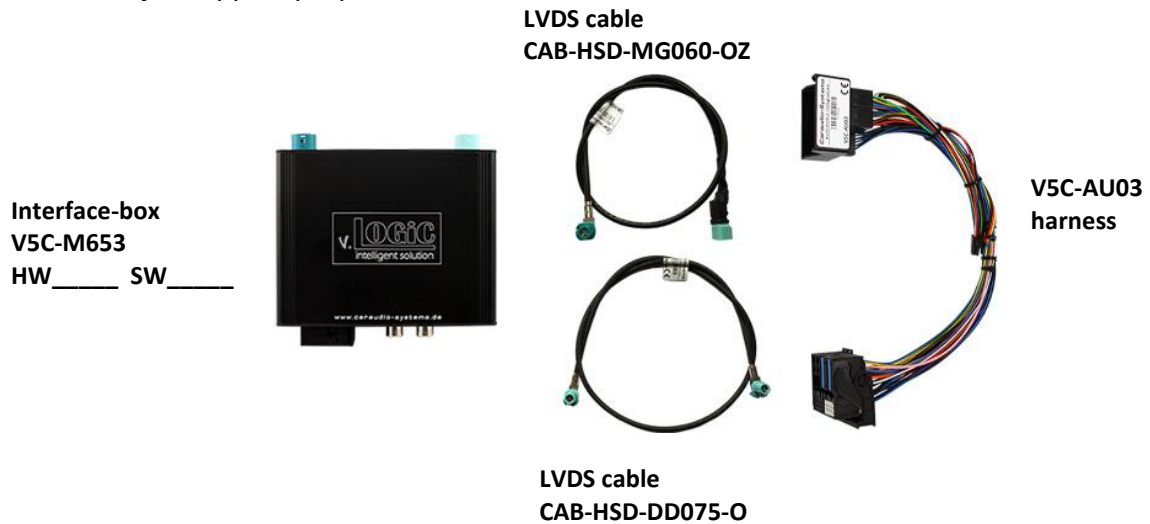

1.2. Check compatibility of vehicle and accessories

Requirements

Navigation Audi MMI3G Basic/High, Audi MMI3G+ High

Factory OPS Display of an optical park display (OPS) isn't possible if an after-market rear-view camera is connected and reverse gear is engaged. Acoustic signals are still existing

Limitations

Unsupported vehicles Audi – A1, Q3.

1.3. Setting the dip switches of the interface-box V5C-M653

Dip 1 on the back of the interface-box V5C-M653 are used to set the monitor type. The default setting is:

Head unit	Dip 1	Dip 2	Dip 3
MMI3G High, MMI3G+ High	ON	OFF	OFF
MMI3G Basic – Version 1	OFF	OFF	OFF
MMI3G Basic – Version 2	OFF	ON	OFF

After each change of the dip switch settings you have to execute a power reset of the interface-box!

1.4. LED's of the interface-box V5C-M653



- Valid input source
- CAN ok
- Power



2. Connection schema

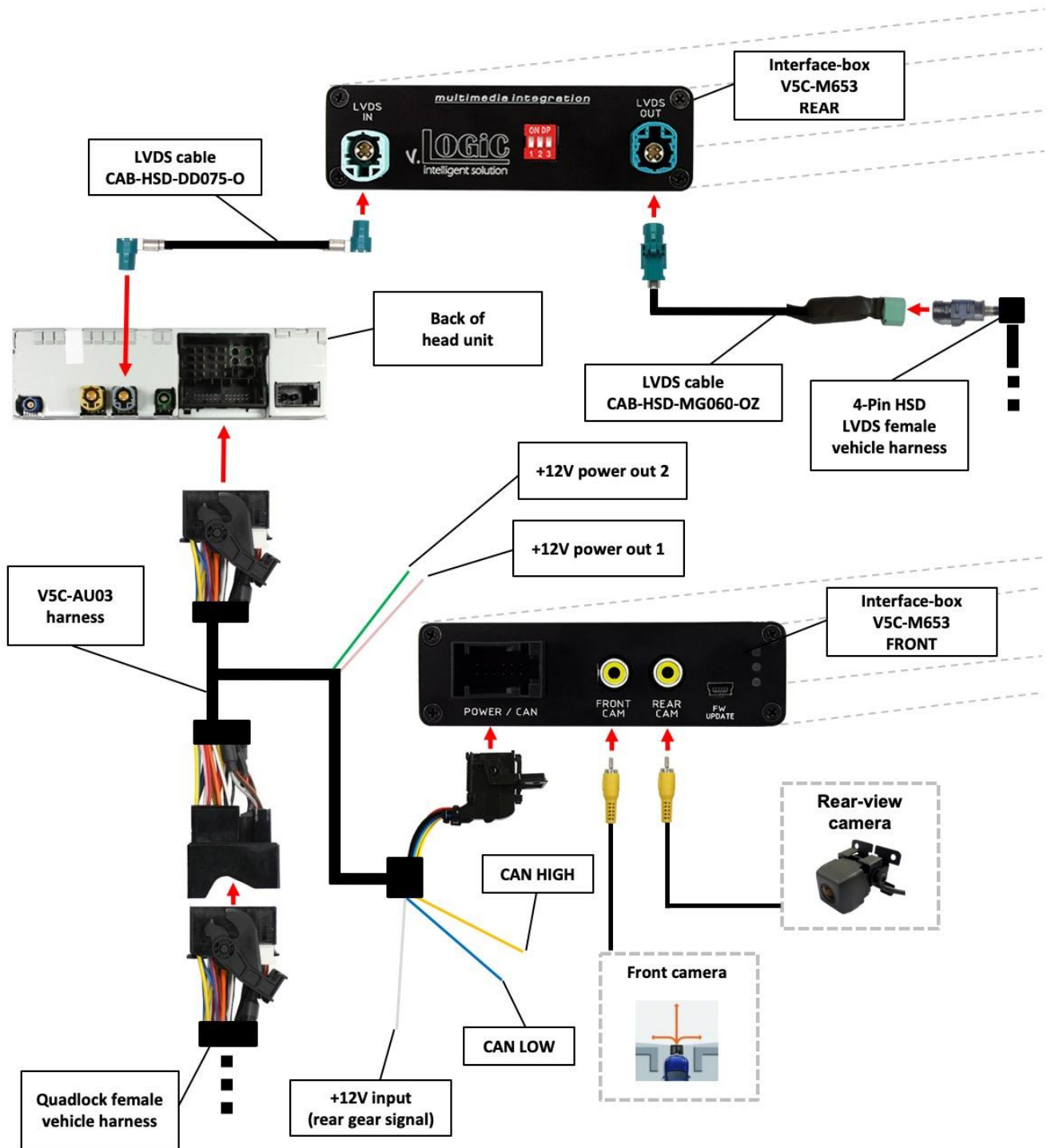

3. Installation

Switch off ignition and disconnect the vehicle's battery! The interface needs a permanent 12V source. If according to factory rules disconnecting the battery is to be avoided, it is usually sufficient to put the vehicle in sleep-mode. In case the sleep-mode does not show success, disconnect the battery with a resistor lead.

If power source is not taken directly from the battery, the connection has to be checked for being start-up proven and permanent.

Prior to wire and device installation we suggest to connect and test correct function of all after-market and factory infotainment equipment!

The interface is installed on the backside of the head unit.

3.1. Connecting interface-box and harnesses

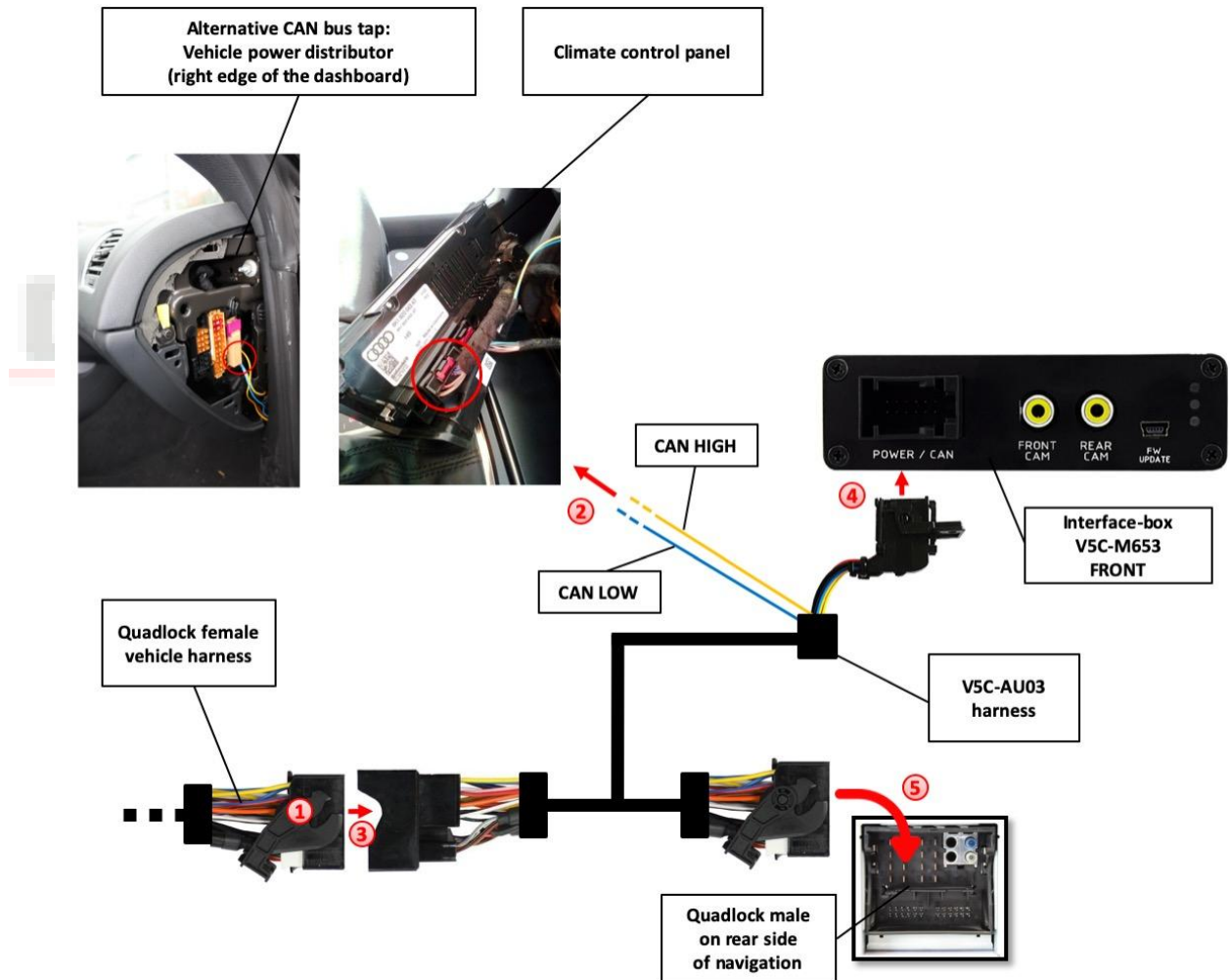

 Remove the female Quadlock connector of the vehicle harness from the rear of the navigation computer.

- 1 Connect the loose blue cable (CAN-low) of harness V5C-AU05 to the orange cable and the loose yellow cable (CAN-high) of harness V5C-AU05 to the orange-green cable on the vehicle climate control panel (note: the vehicle CAN bus wires are twisted).

Alternative CAN bus tap:

Connect the loose blue cable (CAN-low) of harness V5C-AU05 to the orange-brown Cable and the loose yellow cable (CAN-high) of harness V5C-AU05 to the orange-purple or orange-green cable on the vehicle power distributor (right edge of the dashboard).

Note for alternative CAN bus tap: The orange cable in the vehicle is always CAN-bus. The cable colour orange-brown is always CAN-low, the additional cable colour of orange for CAN-high can vary.

- 2 Connect female Quadlock connector of vehicle harness to the male Quadlock connector of harness V5C-AU03.
- 4 Connect female 12pin AMP connector of the harness V5C-AU03 to the front site of the V5C-M653 interface box.
- 3 Connect female Quadlock connector of harness V5C-AU03 to the male Quadlock connector of the navigation computer.



3.2. LVDS connection

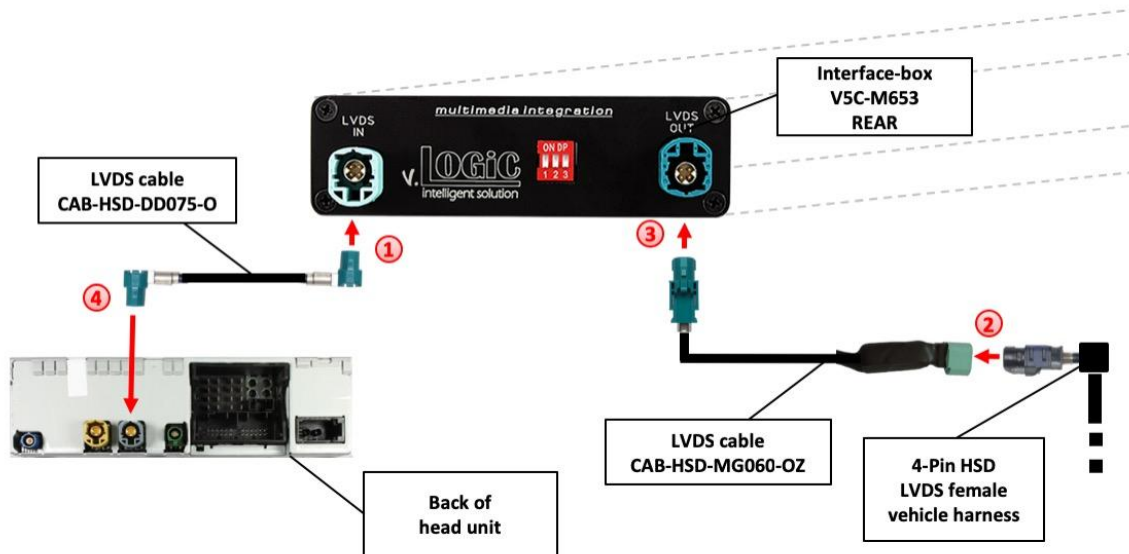

- 1 Connect the female 4pin HSD LVDS connector of the LVDS cable CAB-HSD-DD075-O to the male 4pin HSD LVDS connector (LVDS-IN) on the rear of the interface-box V5C-M653.
- 2 Remove the grey female 4pin HSD LVDS connector of the vehicle harness at the back of the head unit and connect it to the male 4pin HSD LVDS of the CAB-HSD-MG060-OZ LVDS cable.
- 3 Connect the female 4pin HSD LVDS connector of the LVDS cable CAB-HSD-MG060-OZ to the male 4pin HSD LVDS connector (LVDS-OUT) on the rear of the interface-box V5C-M653.
- 4 Connect the female 4pin HSD LVDS connector of the LVDS cable CAB-HSD-DD075-O to the grey male 4pin HSD LVDS connector on the rear of the head unit.

3.2.1. After-market front camera

3.2.1.1. Connection to the after-market front camera

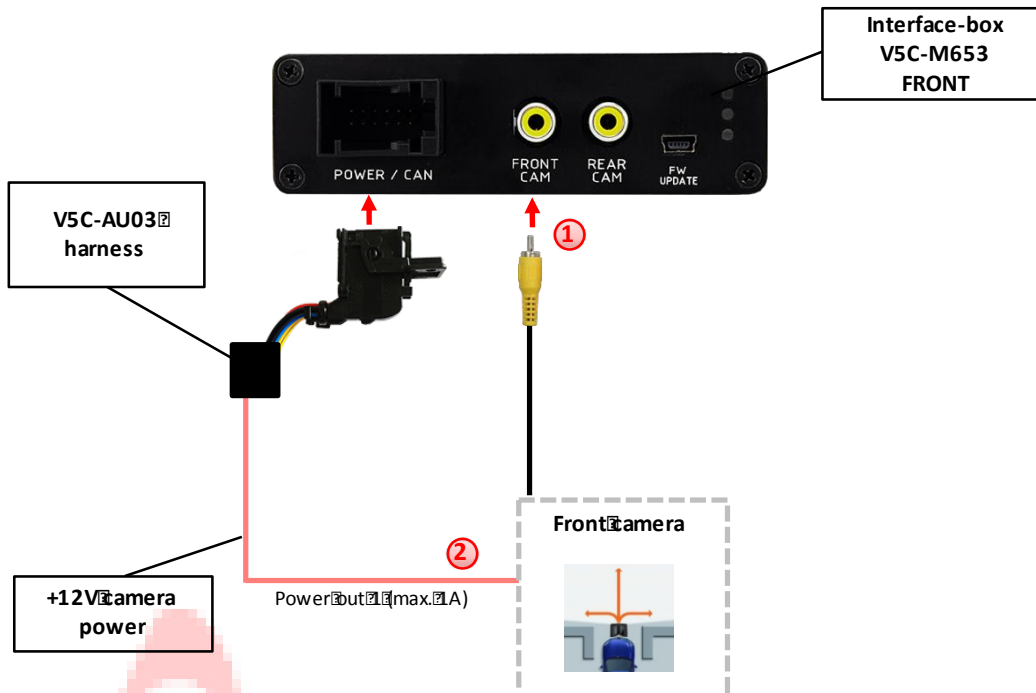

1 Connect the video RCA of the after-market front camera to the female RCA connector "FRONT CAM" of the interface box V5C-M653.

2 The pink wire of harness V5C-AU03 can be used for +12V electric power supply (max. 1A) of the after-market front camera. Configure in the OSD-menu "OPTION", menu item "POWER OUT 1" the designated electric power supply (see chapter "Configurable switching outputs").



3.2.1.2. Settings for connecting an after-market front camera

You have to configure some settings in the OSD-menus INPUTS and MISC if you want to connect an after-market front camera (Operation of the OSD: see chapter “OSD-Operation”).



OSD-menu	Menu item	Setting	Explication
INPUT	FVC	OFF	No front camera connected
		ON	Switches to front camera if parking process is enabled and reverse gear is released
OPTION	PARK LOGIC	CRGearSpeed	Enabled while parking process and up to 30 km/h
		CRGearTime	Enabled while parking process and up to 20 second
		ARGearTime	Enabled with +12V on white wire and up to 20 second
		PDC	No function

Note: You can deactivate the enabled parking process by long pressing (3 sec.) the “control knob” button.

3.2.2. After-market rear-view camera

3.2.2.1. Connection to the after-market rear-view camera

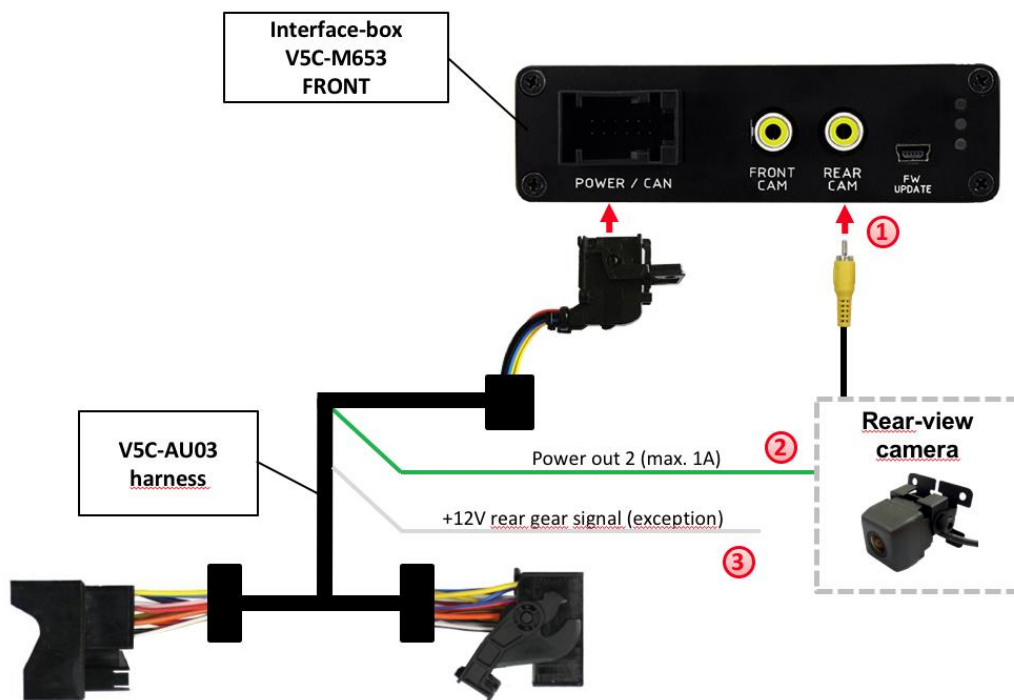

CAR INTERFACE

1 Connect the video RCA of the after-market rear-view camera to the female RCA connector "REAR CAM" of the interface box V5C-M653.

2 The green wire of harness V5C-AU03 can be used for +12V electric power supply (max. 1A) of the after-market rear-view camera. Configure in the OSD-menu "OPTION", menu item "POWER OUT 2" the designated electric power supply (see chapter "Configurable switching outputs").



3 Exception: The white wire of harness V5C-AU03 to reverse light signal (+12V of reverse light) if the system doesn't switch to the rear-view camera automatically after the described OSD-setup (see next chapter).

3.2.2.2. Settings for connecting an after-market rear-view camera

You have to configure some settings in the OSD-menus INPUT and OPTION if you want to connect an after-market rear-view camera (Operation of the OSD: see chapter “OSD-Operation”).



OSD-menu	Menu item	Setting	Explication
INPUT	RVC	OFF	No rear-view camera connected
		ON	Switches to rear-view camera if reverse gear is engaged and/or PDC-display is displayed
OPTION	PARK LOGIC	CRGearOnly	Enabled while parking process
		ARGearOnly	Enabled with +12V on white wire
		CRGearSpeed	Enabled while parking process and up to 30 km/h
		CRGearTime	Enabled while parking process and up to 20 second
		ARGearTime	Enabled with +12V on white wire and up to 20 second
		PDC	Keine Funktion
	RVC GRAPHIC	OFF	Interactive lane lines deactivated
		LINES	Interactive lane lines activated

Note: You can deactivate the enabled parking process by long pressing (3 sec.) the “control knob” button.

3.2.2.3. Settings for OEM rear-view camera

OSD-menu	Menu item	Setting	Explication
INPUT	RVC	OEM	If a factory rear-view camera is existing! The interface turns off, if reverse gear is enabled and it displays factory rear-view camera
OPTION	PARK LOGIC	RGearSpeed	Enabled while parking process and up to 30 km/h

3.2.3. Configurable trigger outputs

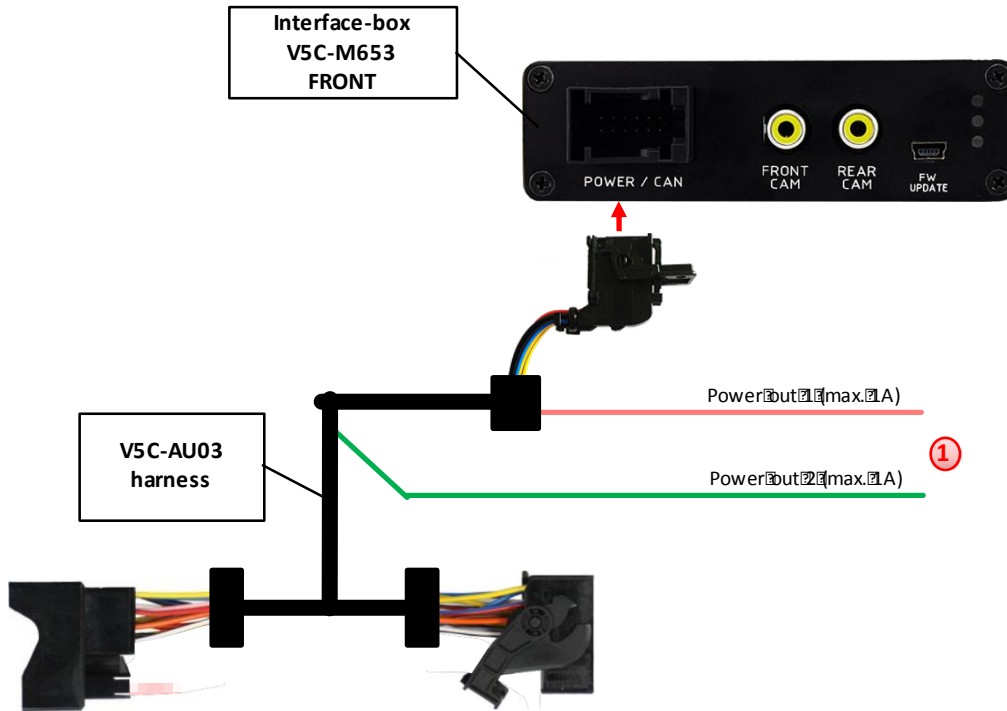

1 You can configure the both +12V trigger outputs separately. The pink wire is POWER OUT 1 and the green wire is POWER OUT 2.

Note: You can configure the both trigger outputs in the OSD-menu OPTION separately (Operation of the OSD: see chapter “OSD-Operation”).



OSD-menu	Menu item	Setting	Explication
OPTION	POWER OUT1 (pink) POWER OUT2 (green)	CAN	+12V when the interface is on (red LED on)
		ACC	+12V when ignition is on
		CAM	+12V when the rear-view camera input is activated
		RGEAR	+12V when reverse gear is engaged
		AVS	+12V when interface video-source is active
		OFF	Trigger output deactivated

3.3. Interactive lane lines

You have to configure some settings in the OSD-menu OPTION if you want to activate interactive lane lines (Operation of the OSD: see chapter “OSD-Operation”).

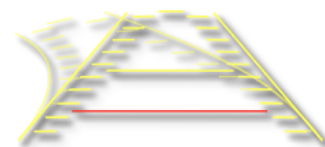

OSD-menu	Menu item	Setting	Explication
OPTION	RVC GRAPHIC	OFF	Interactive lane lines deactivated
		LINES	Interactive lane lines activated
	CAR TYPE	A1/A4/A5/A6/ A7/A8/Q5/Q7	Vehicle type selection

3.4. Picture settings

You can change the picture settings in the OSD-menu IMAGE (activation only from interface video level possible – push “SETUP” button for 3 sec.).

- Brightness
- Contrast
- Saturation
- Hue
- Sharpness

Note: The picture settings will be retained for each AV-source separately.

4. Operation

4.1. OSD – On-screen display

You can change the basic configurations of the interface in the OSD (on screen display).



4.1.1. OSD – Operation

You can control the OSD by MMI control buttons.



4.1.2. OSD – Additional setting options

The following settings in the OSD-menus OPTION and OSD can be configured over and above the described settings in this manual (Operation of the OSD: see chapter “OSD-Operation”):



OSD-menu	Menu item	Setting	Explication
OSD	POS. X	0-xxx	Horizontal position of the OSD
	POS. Y	0-xxx	Vertical position of the OSD
	SIZE	SMALL	Small OSD menu windows
		LARGE	Large OSD menu windows
	OSD TIMEOUT	2-20	Time setting for automatic OSD shutoff
INFO	VERSION	X.XX.XX	Displays the current SW-version
OPTION	FACTORY RESET		Resetting to factory settings



4.2. Selecting the interface as current video-source



Long press "MEDIA" button to choose the interface as current video source.

Short press "MEDIA" button switch the video sources (cameras). Each short press will switch to the next enabled input. If all inputs are enabled the order is:

FRONT CAM → REAR CAM → ...

Inputs which are not enabled are skipped.

The exiting of the video interface level is achieved by long press of **BACK** button or short press of „**NAV**“, „**CAR**“, „**SETUP**“, „**RADIO**“, „**NAME**“, „**TEL**“ button.

5. Specifications

Operation voltage	10.5 – 14.8V DC
Stand-by power drain	<0,1mA
Operation power drain	190mA
Power consumption	2,6W
Temperature range	-20°C to +80°C
Weight (box only)	285g
Measurements (box only) B x H x T	141 x 30 x 105 mm

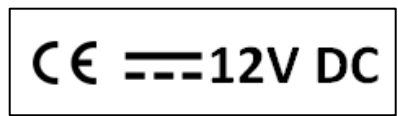

6. Connections (interface-box)

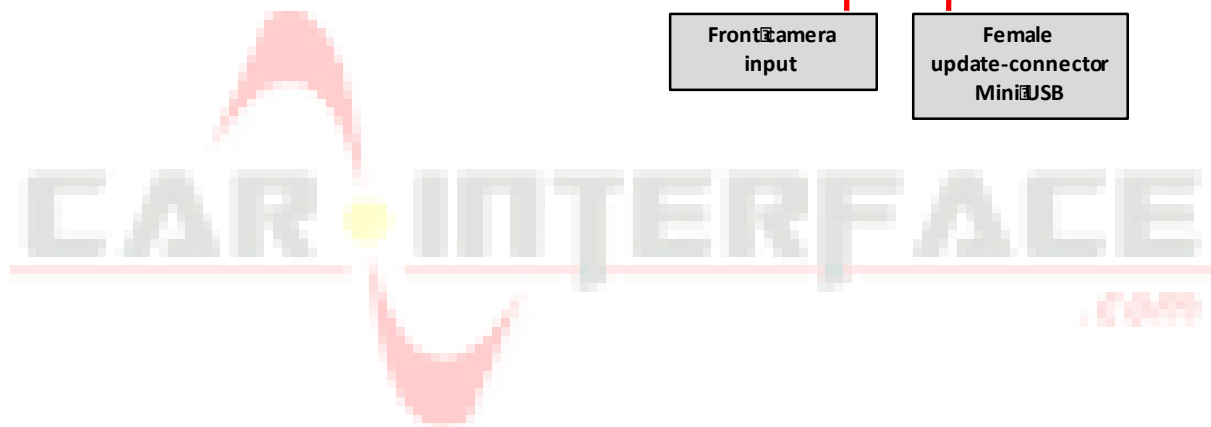
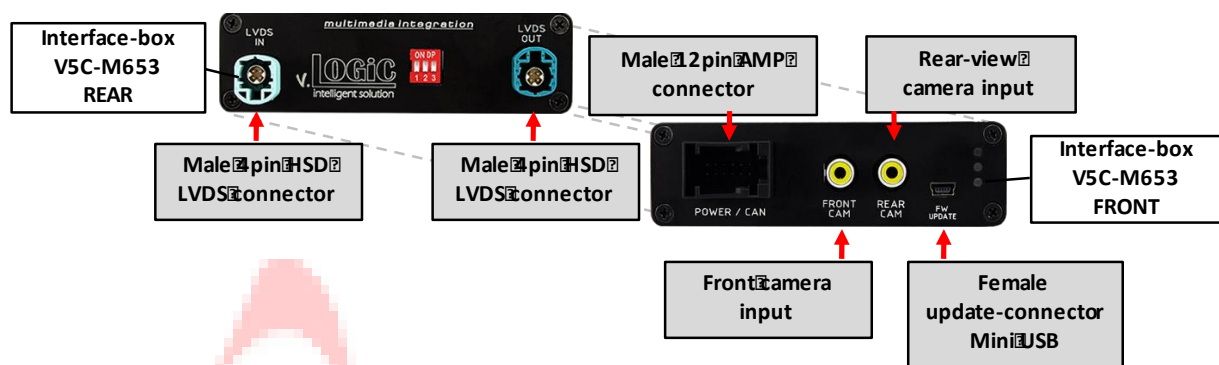

Legal disclaimer: Mentioned company and trademarks, as well as product names/codes are registered trademarks ® of their corresponding legal owners.