

v.LiNK Video-inserter CI-RL2-MTC

Compatible with
MASERATI vehicles
with Maserati Touch Control (MTC) infotainment



example

**Video-inserter with 2 video inputs, rear-view camera input
and CAN-bus communication**

Product features

- Video-inserter for factory-infotainment systems
- 2 CVBS video-inputs for after-market devices (e.g. USB-player, DVB-T2 tuner)
- Rear-view camera CVBS video-input
- Automatic switching to rear-view camera input on engagement of the reverse gear
- Video-in-motion (ONLY for connected video-sources)
- Video-inputs NTSC and PAL compatible

Contents

1. Prior to installation

- 1.1. Delivery contents
- 1.2. Checking the compatibility of vehicle and accessories
- 1.3. Boxes and connectors
 - 1.3.1. Video-Interface
 - 1.3.2. CAN-bus box
 - 1.3.3. Dip-switch settings – interface
 - 1.3.3.1. Enabling the interface's video inputs (dip 2-3)
 - 1.3.3.2. Rear-view camera setting (dip 5)
 - 1.3.3.3. Monitor specific settings (dip8)

2. Installation

- 2.1. Place of installation
 - 2.1.1. Place of Installation – video interface and CAN-bus box
- 2.2. Connection schema
- 2.3. Connection - video-interface and Power/CAN
- 2.4. Analogue connection - video-interface
- 2.5. Connection – picture signal cable
- 2.6. Connection – video sources
- 2.7. After-market rear-view camera
 - 2.7.1. Case 1: CAN-box receives the reverse gear signal
 - 2.7.2. Case 2: CAN-box does not receive the reverse gear signal
- 2.8. Connection – video interface and external keypad
- 2.9. Picture settings

3. Video interface operation

- 3.1. By infotainment button
- 3.2. By external keypad
- 3.3. By white wire of the 6pin to 8pin cable

4. Specifications

5. FAQ – Trouble Shooting-Interface functions

Legal Information

By law, watching moving pictures while driving is prohibited, the driver must not be distracted. We do not accept any liability for material damage or personal injury resulting, directly or indirectly, from installation or operation of this product. Apart from using this product in an unmoved vehicle, it should only be used to display fixed menus or rear-view-camera video when the vehicle is moving (for example the MP3 menu for DVD upgrades).

Changes/updates of the vehicle's software can cause malfunctions of the interface. Up to one year after purchase we offer free software-updates for our interfaces. To receive a free update, the interface has to be sent in at own cost. Wages for de-and reinstallation and other expenditures involved with the software-updates will not be refunded.

No liability for vehicle wire colours and pin definition!

Changes by the vehicle manufacturer are possible. The given information has to be verified by the installer.

1. Prior to installation

Read the manual prior to installation. Technical knowledge is necessary for installation. The place of installation must be free of moisture and away from heat sources.

1.1. Delivery contents

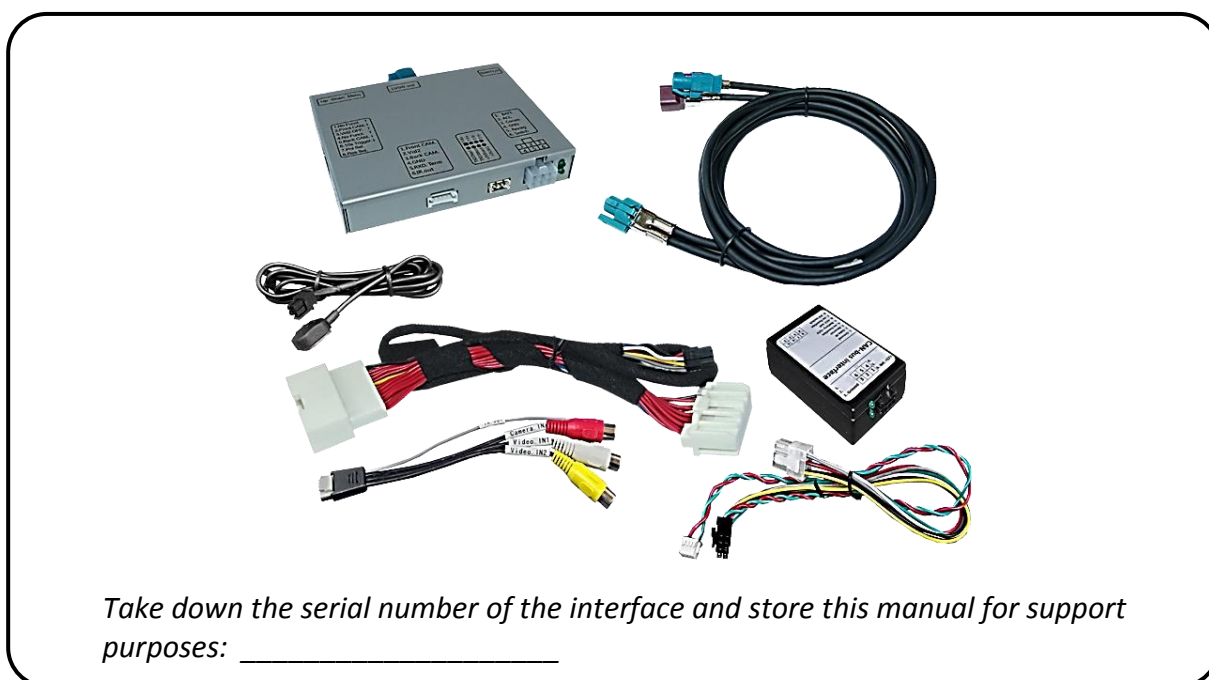

1.2. Checking the compatibility of vehicle and accessories

Requirements		
Brand	Compatible vehicles	Compatible systems
Maserati	Ghibli since model year 2014 Quattroporte since model year 2014	Maserati Touch Control (MTC)
Limitations:		
<i>Video only</i>	The interface inserts ONLY video signals into the infotainment. For inserting Audio signals either the possibly existing factory audio-AUX-input or a FM-modulator can be used.	
<i>Factory rear-view camera</i>	Automatically switching-back from inserted video to factory rear-view camera is only possible while the reverse gear is engaged. To delay the switch-back an additional electronic part is required.	

1.3. Boxes and connectors

1.3.1. Video Interface

The video-interface converts the video signals of connected after-market sources in a factory monitor compatible picture signal which is inserted in the factory monitor, by using separate trigger options. Further it reads the vehicle's digital signals out of the vehicle's CAN-bus and converts them for the video interface.

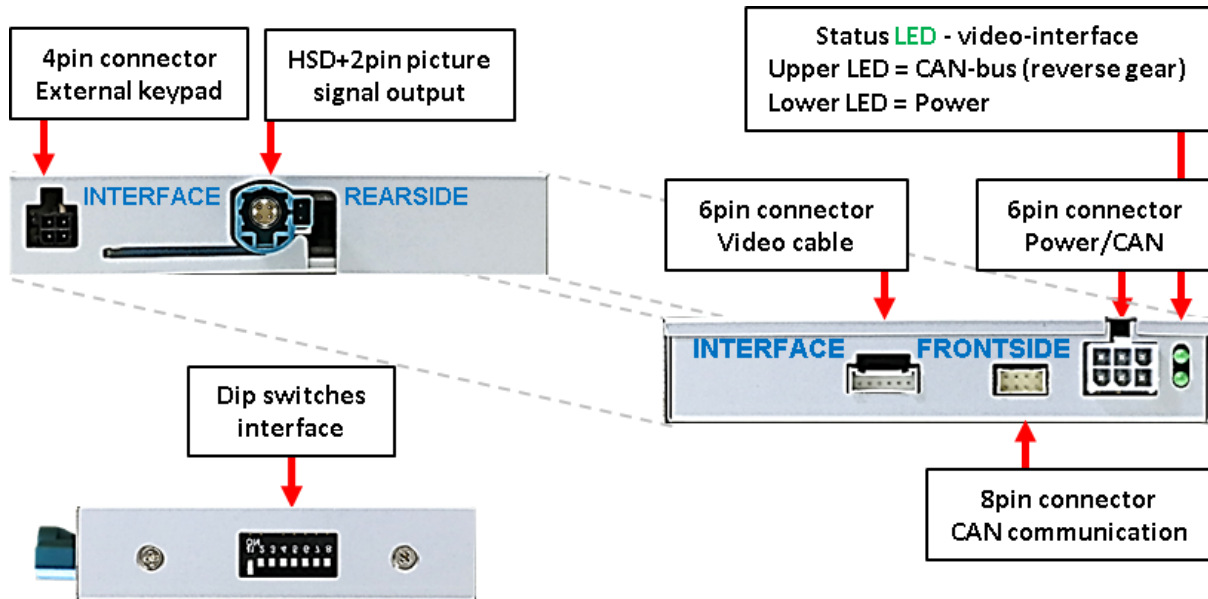

1.3.2. CAN-bus box

The CAN box reads the vehicle's digital signals out of the vehicle's CAN-bus and converts them for the video interface.

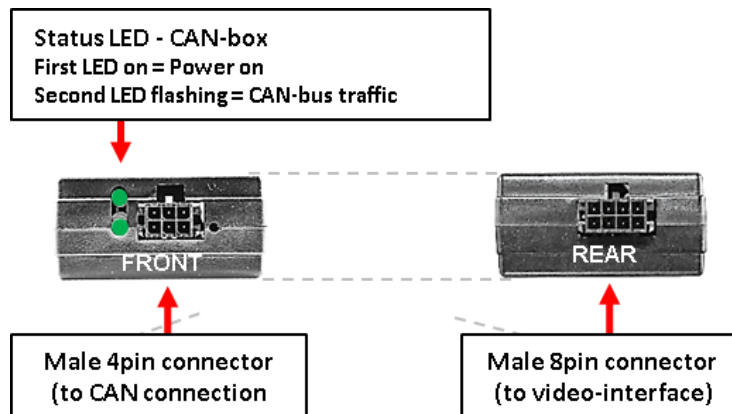

1.3.3. Dip-switch settings – interface

Some settings have to be selected by the dip-switches on the video interface. Dip position down is ON and position up is OFF.



Dip	Function	ON (down)	OFF (up)
1	No function		set to OFF
2	CVBS AV1-input	enabled	disabled
3	CVBS AV2-input	enabled	disabled
4	No function		set to OFF
5	Rear-view cam type	after-market	factory or none
6	No function		set to OFF
7	No function		set to OFF
8	Monitor adjustment	4.3inch monitor	8.4inch monitor

In case of a non-optimal displayed picture with the mentioned dip setting of dip8, we recommend to try the other dip switch position.

After each Dip-switch-change a power-reset of the Can-box has to be performed!

See the following chapters for detailed information.

1.3.3.1. Enabling the interface's video inputs (dip 2-3)

Only the enabled video inputs can be accessed by switching through the interface's video sources. It is recommended to enable only the required inputs, because the disabled inputs will be skipped while switching through the video interfaces inputs.

1.3.3.2. Rear-view camera setting (dip 5)

If set to **OFF**, the interface switches to factory LVDS picture while the reverse gear is engaged to display factory rear-view camera or factory optical park system picture.

If set to **ON**, the interface switches to its rear-view camera input while the reverse gear is engaged.

1.3.3.3. Monitor specific settings (dip8)

Dip8 customizes the monitor-specific video settings.

Dip switch setting **ON** will support the 4.3inch monitor.

Dip switch setting **OFF** will support the 8.4inch monitor.

Note: Dip 1, 4, 6 and 7 are out of function and have to be set to **OFF**.

2. Installation

To install the interface, first switch off the ignition and disconnect the vehicle's battery. Please read the owner's manual of the car, regarding the battery's disconnection! If required, enable the car's Sleep-mode (hibernation mode)

In case the sleep-mode does not succeed, the disconnection of the battery can be done with a resistor lead.

If the necessary stabilized power supply for the interface is not taken directly from the battery, the chosen connection has to be checked for being constantly stable.

The interface needs a permanent 12V source!

2.1. Place of installation

2.1.1. Place of installation – video interface and CAN-bus box

The interface box and the CAN-bus box are prepared to be connected behind the vehicle's monitor and head-unit. Both parts have to be removed for the installation

2.2. Connection schema

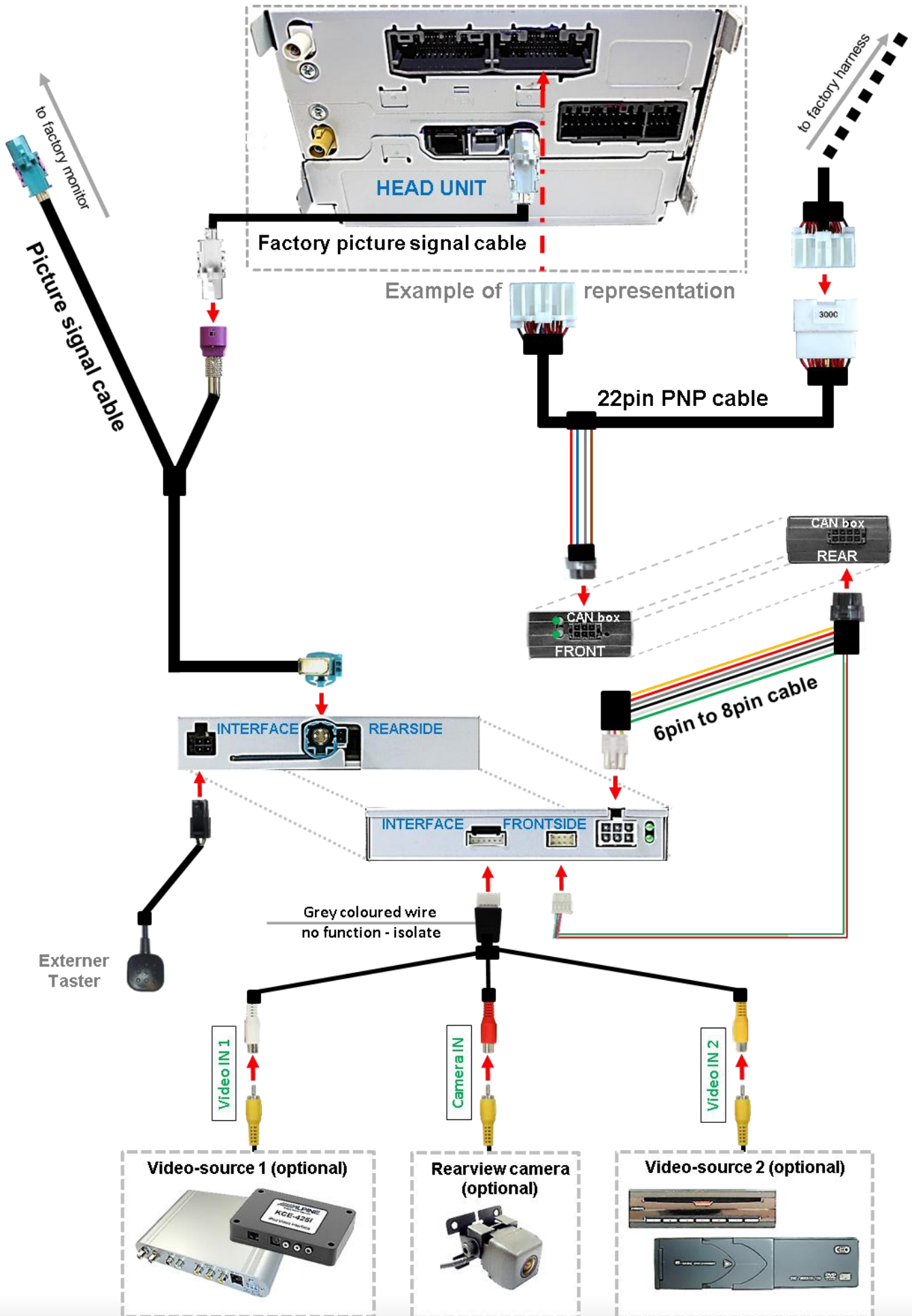

2.3. Connection - video-interface and Power / CAN

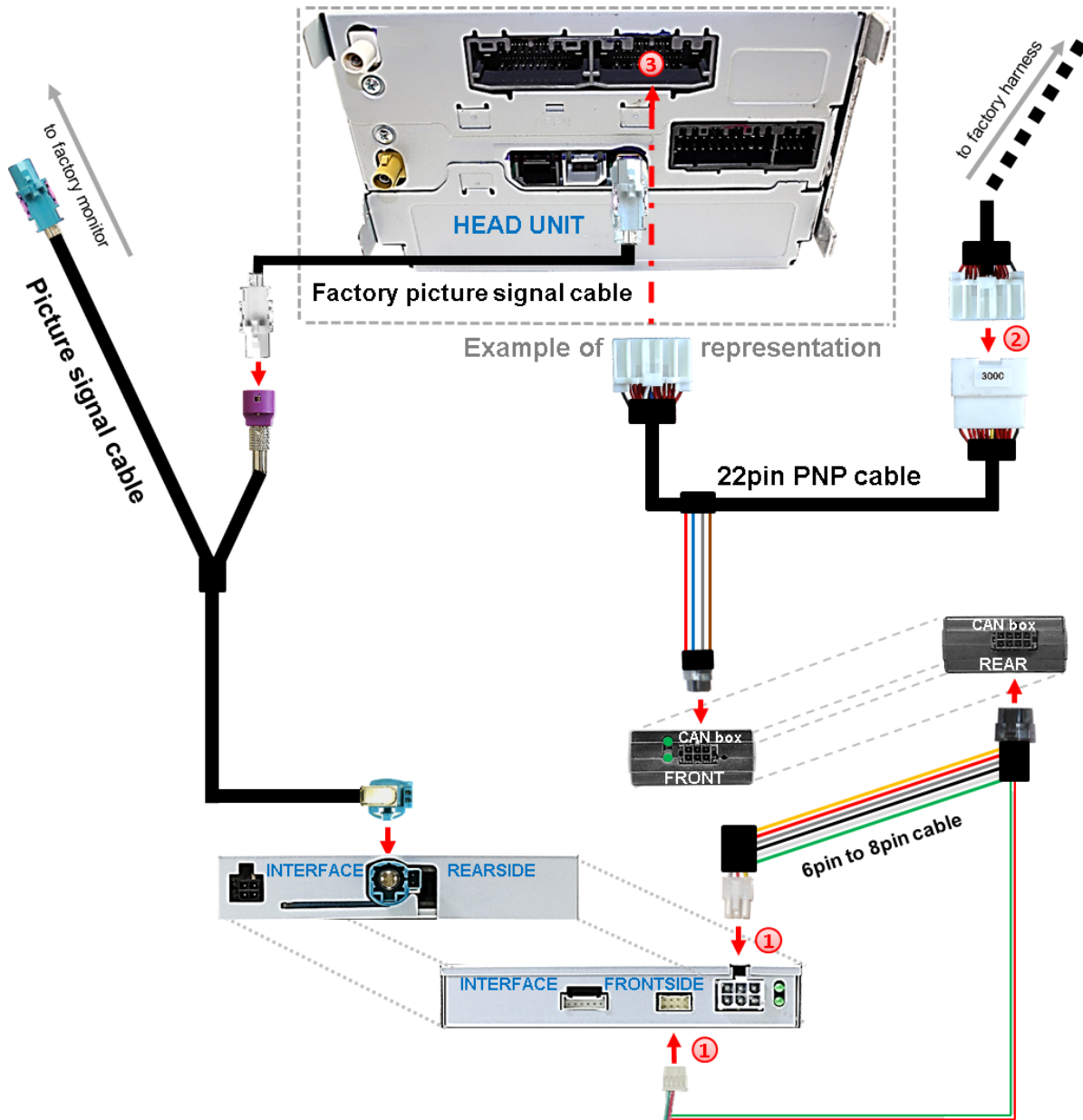

- ① Connect the 6pin to 8pin cable's both white female 6pin and 8pin connectors to the male 6pin and 8pin connectors of the video interface.
- ② Disconnect the female 22pin connector of the factory harness at the rear-side of the head unit and connect it to the 22pin PNP cable's male 22pin connector.
- ③ Connect the 22pin PNP cable's opposite female 22pin connector to the previously become free male 22pin connector at the rear-side of the head unit.

Check 1







Exceptionally, the CAN communication may not succeed in all vehicles! If, after connecting the PNP harness, no interface LED lightens up while the ignition is turned on, the analog power supply needs to be done! (see following chapter)

Check 2

Exceptionally, the power supply to the video interfaces may not be interrupted after switching to the vehicle's sleep mode. If the interface LEDs continue to shine even in the vehicle's sleep mode, please contact the support!

2.4. Analogue connecting - video-interface

If the communication between the CAN box and the vehicle's CAN bus does not succeed (not all vehicles are compatible), an analogue connection is required by connecting the 6pin to 8pin cable without the CN box.

Pin-Configuration White 6-Pin Power Connector	
	Pin 1 – ACC or Battery+12V
	Pin 2 – ACC+12V
	Pin 3 – CAN-Bus Control Data
	Pin 4 – Ground
	Pin 5 – Switch Input Rear View Camera shifts to CAM after +12V Signal
	Pin 6 – AV-Switch-Signal +5-12V Impulse

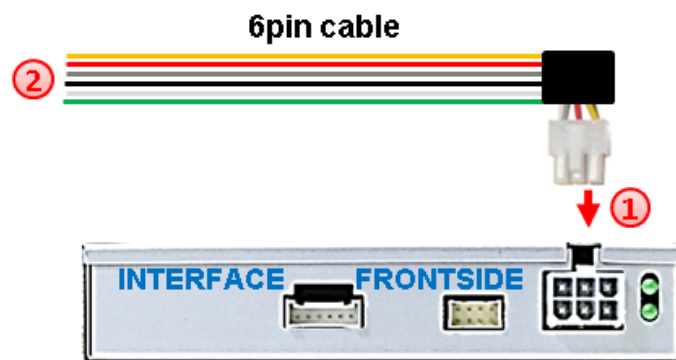

- ① Connect the female 6pin connector of the 6pin to 8pin cable to the 6pin connector of the video interface.
- ② Connect the yellow, the red and the black wire of the 6pin to 78pin cable to the vehicle's power and ground.

Note: The connection of the green wire (Reverse signal) will be described in chapter "After-market rear-view camera". The white wire, can be used to switch the enabled video sources, same as the keypad (see chapter "video interface-operation"). The grey wire stays unconnected.

2.5. Connection - picture signal cable

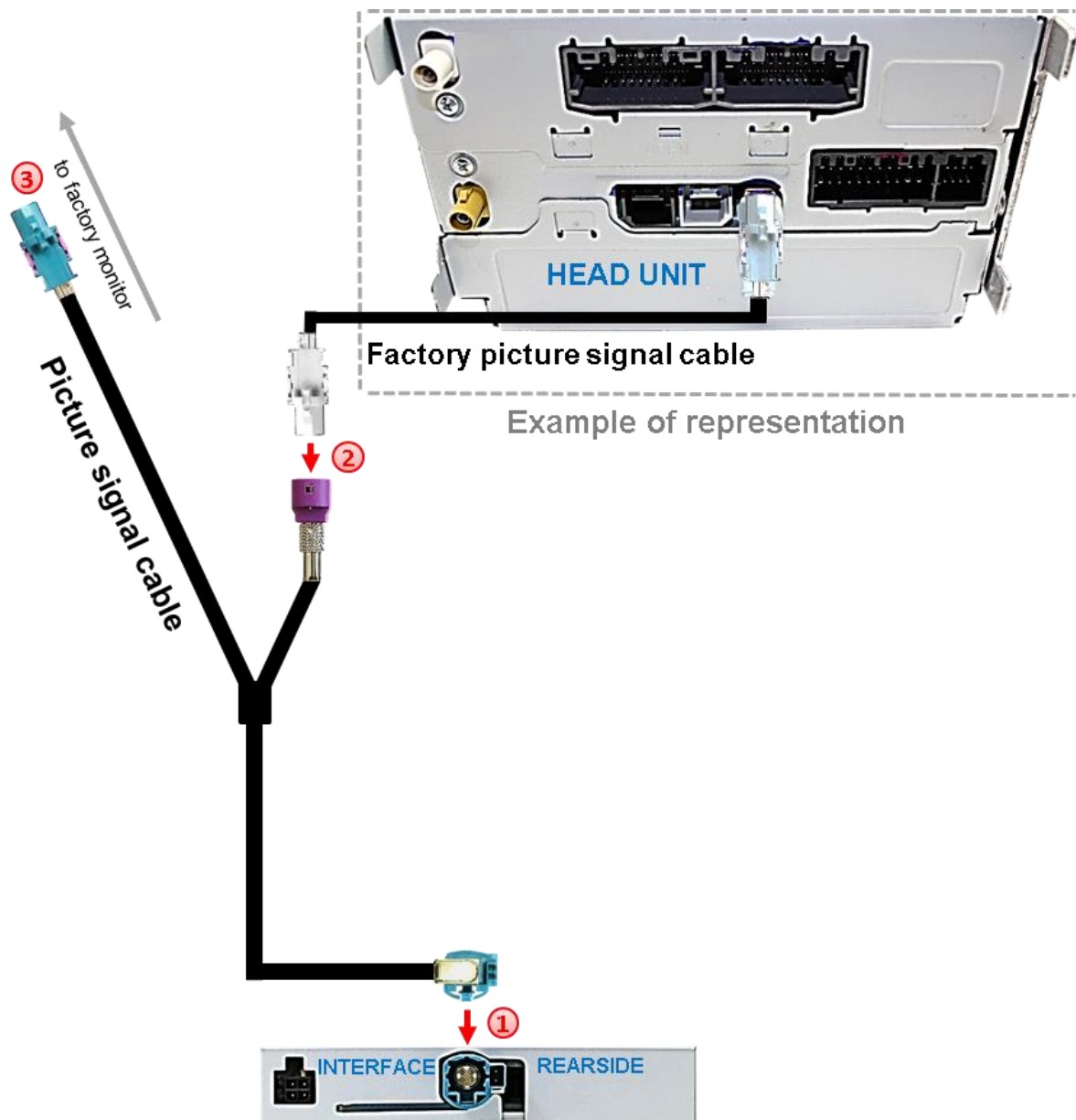

- ① Connect the enclosed picture signal cable's female waterblue coloured HSD+2 connector to the male waterblue coloured HSD+ 2 connector of the video interface.
- ② Disconnect the factory picture signal cable's female 4pin HSD connector **at the rear side of the factory monitor** and connect it to the purple colored male 4pin HSD connector of the enclosed picture signal cable.



Attention: The factory picture signal cable has to be kept connected to the head unit during the installation process!

- ③ Connect the picture signal cable's waterblue coloured female 4pin HSD connector to the previously become free white coloured male 4pin HSD connector at the rear side of the factory monitor.

2.6. Connection - Video-sources

It is possible to connect two after-market video sources and one after-market rear-view camera to the video-interface.

Before final installation of the peripheral devices, we recommend a test-run to detect a incompatibility of vehicle and interface. Due to changes in the production of the vehicle manufacturer there's always a possibility of incompatibility.

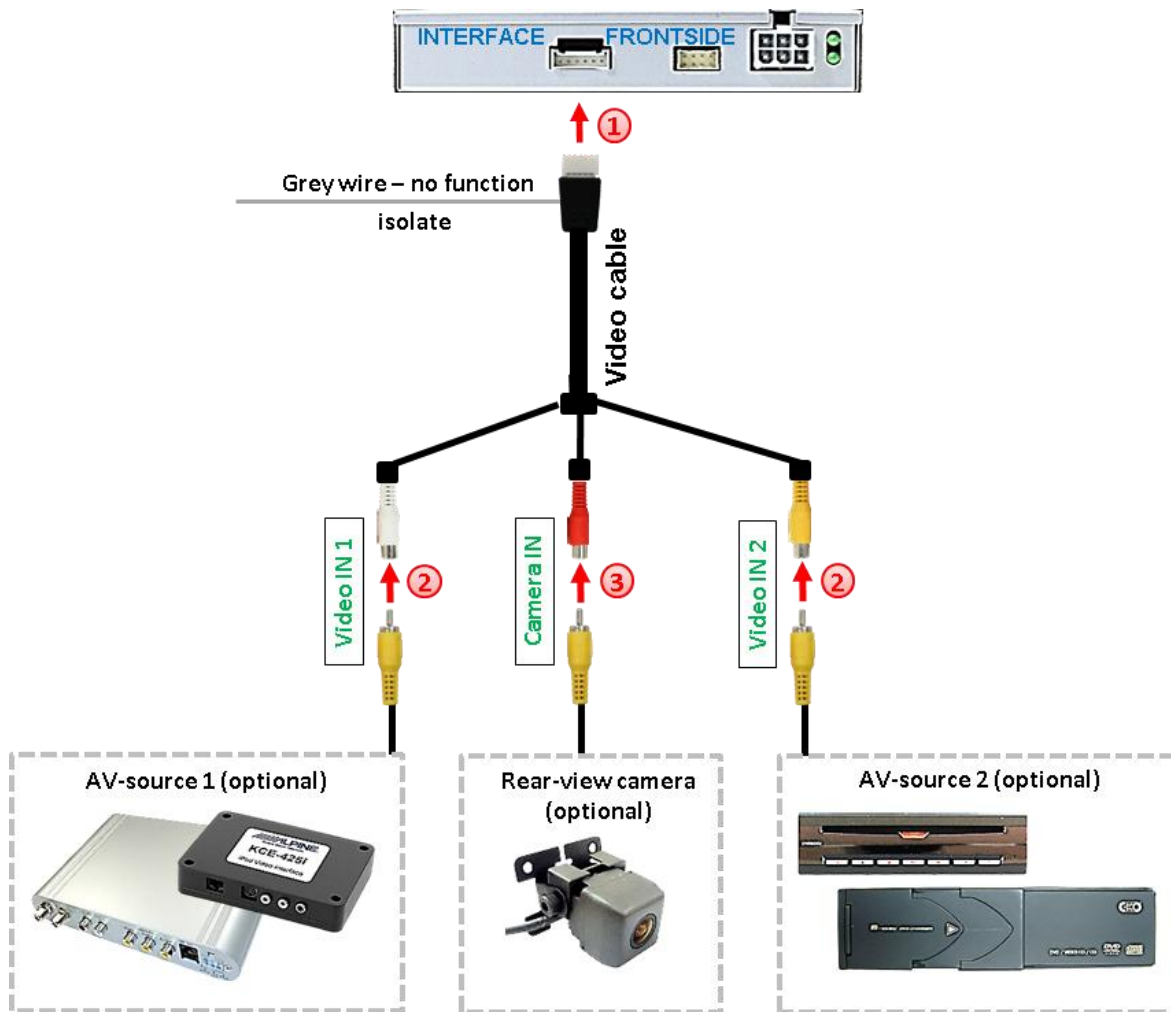

- ① Connect the video cable's female 6pin connector to the video interface's male 6pin connector.
- ② Connect the RCA of the video source 1 and video source 2 to the video cable's female RCA „Video IN1“ and „Video IN2“.
- ③ Connect the rear-view camera's RCA to the video cable's female RCA „Camera IN“.

2.7. After-market rear-view camera

Some vehicles have a different reverse gear code on the CAN-bus which the included CAN-box is not compatible with. In this case there are two different ways of installation. If the CAN-box is able to detect an enabled vehicle's reverse gear, the green wire of the 6pin to 8pin cable carries +12V while the reverse gear is engaged.

Note: Do not forget to set dip5 of video-interface to ON before testing.

2.7.1. Case 1: CAN-box receives the reverse gear signal

If the CAN-bus box delivers +12V on the green wire of the 6pin to 8pin cable while reverse gear is engaged, the video interface will automatically switch to the rear-view camera input „CAMERA IN“ while the reverse gear is engaged.

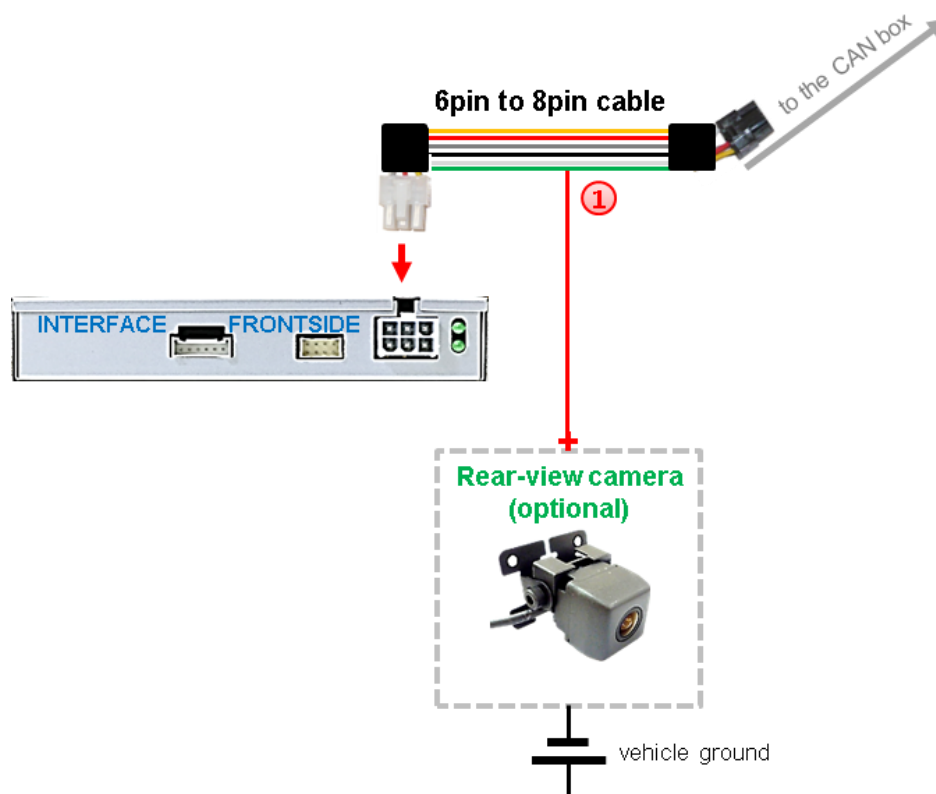

- ① Additionally, the +12V (max. 500mA) power supply for the rear-view camera can be taken from the green wire of the 6pin to 8pin cable.

2.7.2. . Case 2: CAN-box does not receive the reverse gear signal

If the CAN-bus interface does not receive +12V on the green wire of the 6pin to 8pin cable when reverse gear is engaged (not all vehicles are compatible) an external switching signal from the reverse gear light is required. As the reverse gear light signal contains electronic interference, a traditional open relay (e.g AC-RW-1230 with wiring AC-RS5) or filter (e.g. AC-PNF-RVC) is required. Below schema shows the use of a relay (normally open).

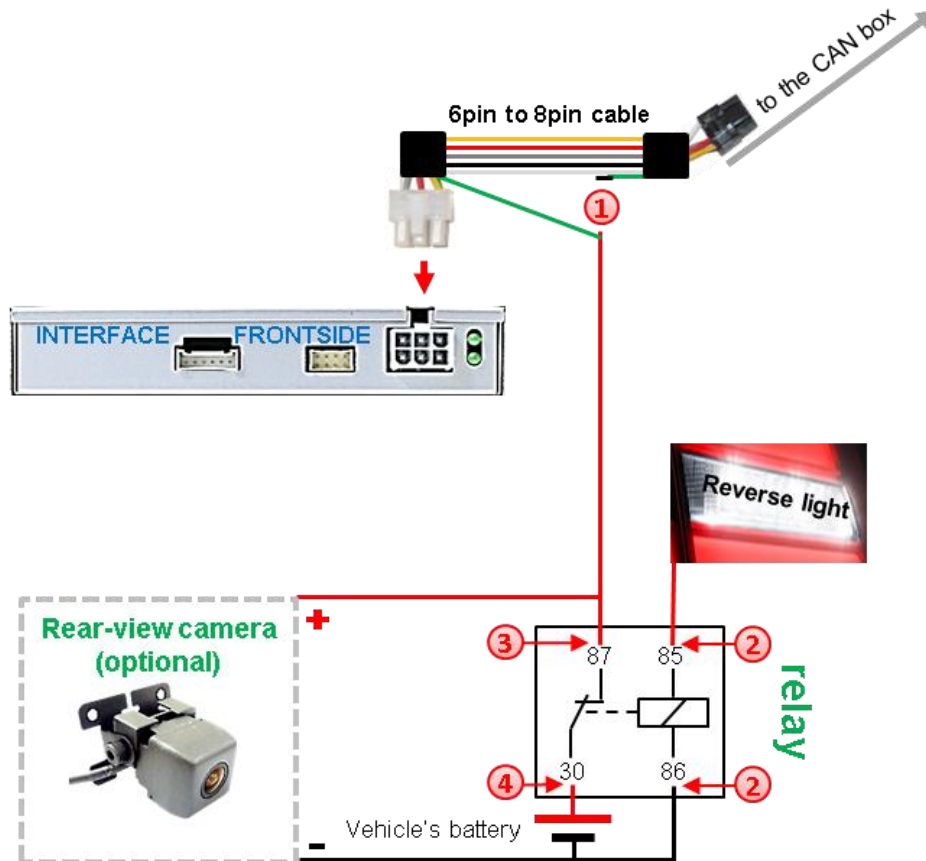

- ❶ Cut the green cable of the 6pin to 8pin cable close to the black 8pin connector and isolate the shorter end of the green cable near to the 8pin connector (CAN-box side).
- ❷ Connect the reverse gear light signal/power to coil terminal (85) and vehicle's ground to coil terminal (86) of relay.
- ❸ Connect the rear-view camera power wire and the green wire (video interface side) of the 6pin to 8pin cable both to output terminal (87) of the relay.
- ❹ Connect permanent battery power to input terminal (30) of relay.

Note: If, due to a missing CAN communication, the 6pin to 8pin cable has been connected the analogue way instead of the Can box, the green wire's connection has also to be done as shown in the picture above.

2.8. Connection - video-interface and external keypad

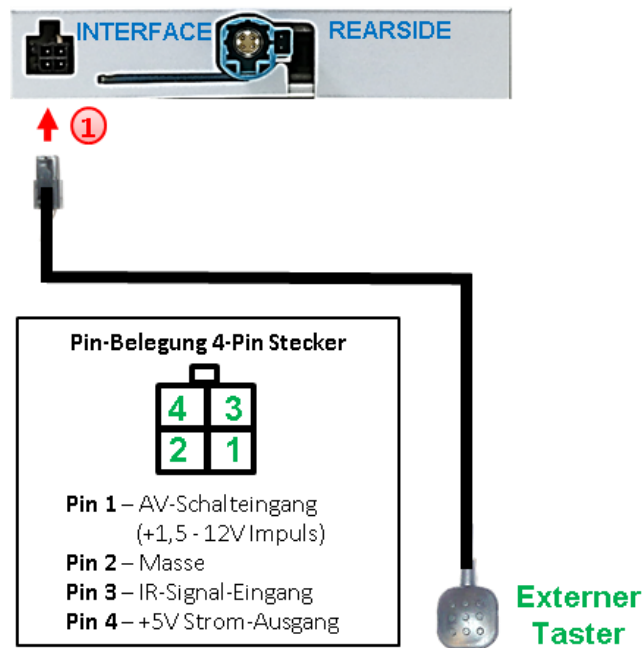

- ① Connect the keypad's female 4pin connector to the video-interface's male 4pin connector.

Note: Even if the switching through several video sources by the keypad mightn't be required, the invisible connection and availability is strongly recommended.

2.9. Picture settings

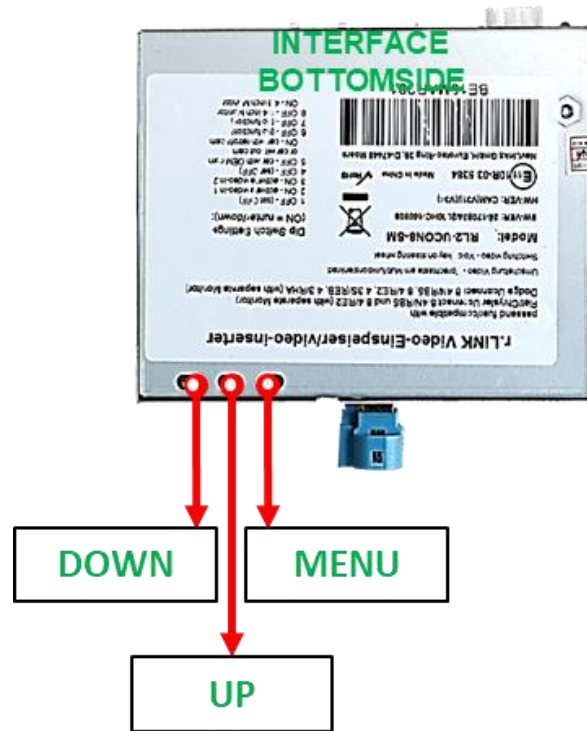

The picture settings are adjustable by the 3 push-buttons on the video-interface. Press the MENU button to open the OSD settings menu or to switch to the next menu item. Press UP and DOWN to change the selected value. The buttons are placed inside in the housing to avoid accidental changes during or after the installation. Picture settings must be done separately for RGB, AV1 and AV2 while the corresponding input is selected and visible on the monitor. **AV2 and CAM share the same settings which must be adjusted in AV2.**

Note: The OSD menu is only shown when a working video source is connected to the selected video-input of the interface.

The following settings are available:

- Contrast
- Brightness
- Saturation
- Position H (horizontal)
- Position V (vertical)
- IR-AV1/2 (no function)
- Guide L/R (no function)
- UI-CNTRL (no function)
- Size H/V (picture size horizontal/vertical)

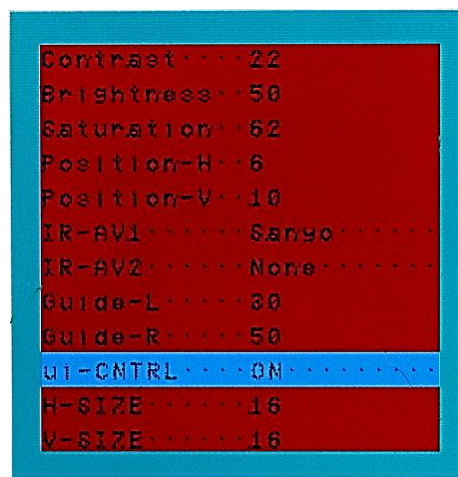

3. Video interface operation

3.1. By infotainment buttons

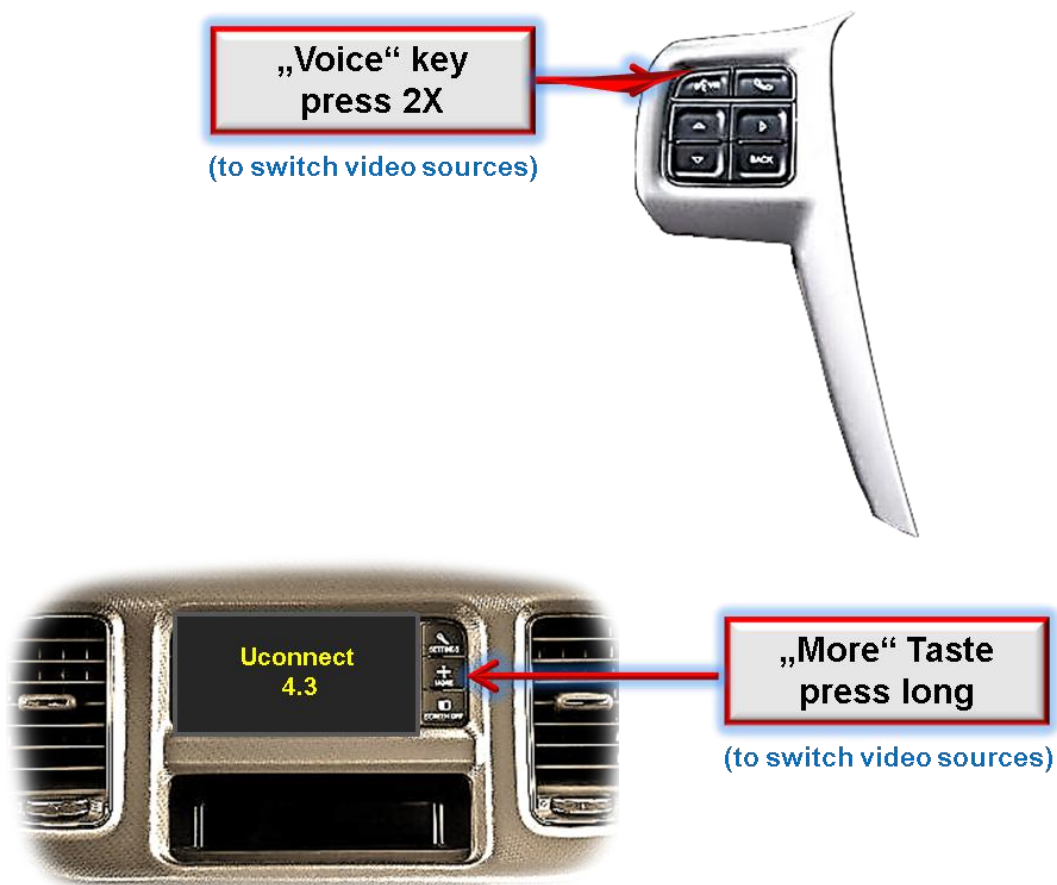

To switch the video sources the vehicle’s **VOICE** button at the steering wheel or, in case of the 4.3inch monitor, the **MORE** button can be used.

A double press of the steering wheels “Voice” key switches to the next activated video input.

A long press of the 4.3inch monitor’s “More” key switches to the next activated video input.

If all inputs are enabled the order is:

Factory video → video IN1 → video IN2 → factory video →...

Disabled inputs will be skipped.

Switchover by vehicle buttons isn’t possible in all vehicles. In some vehicles the external keypad or the white wire of the 6pin to 8pin cable has to be used (see following chapter).

3.2. By external keypad

Alternatively or additionally to the factory infotainment buttons, the interface's external keypad can be used to switch the enabled inputs.

A 2-3 seconds press of the keypad switches the video-source.

Each long press will switch to the next enabled input. Inputs which are not enabled are skipped.

3.3. By white wire of the 6pin to 8pin cable

Alternatively or additionally to the factory infotainment button, the white wire of the 6pin to 8pin cable can be used to switch the enabled inputs.

Every +5-12V pulse switches the video interface to the next enabled input.

4. Specifications

BATT/ACC range	7V - 25V
Stand-by power drain	50mA
Power	280mA
Video input	0.7V - 1V
Video input formats	NTSC/PAL
RGB-video amplitude	0.7V with 75 Ohm impedance
Temperature range	-40°C to +85°C
Dimensions video-box	112 x 23 x 111 mm (W x H x D)
Dimensions CAN-box	72 x 23 x 44 mm (W x H x D)

5. FAQ – Trouble shooting Interface functions

For any troubles which may occur, check the following table for a solution before requesting support from your vendor.

Symptom	Reason	Possible solution
No picture/black picture (factory picture).	Not all connectors have been reconnected to factory head-unit or monitor after installation.	Connect missing connectors.
	No power on CAN-bus box (all LED CAN-bus box are off).	Check power supply of CAN-bus box. Check CAN-bus connection of CAN-bus box.
	CAN-bus box connected to CAN-bus in wrong place.	Refer to the manual where to connected to the CAN-bus. If not mentioned, try another place to connect to the CAN-bus.
	No power on video-interface (all LED video-interface are off).	Check whether CAN-bus box delivers +12V ACC on red wire output of 8pin to 6pin cable. If not cut wire and supply ACC +12V directly to video-interface.
No picture/black picture/white picture (inserted picture) but factory picture is OK.	No picture from video source.	Check on other monitor whether video source is OK.
	No video-source connected to the selected interface input.	Check settings dips 1 to 3 of video interface which inputs are activated and switch to corresponding input(s).
	LVDS cables plugged in wrong place.	Double-check whether order of LVDS cables is exactly connected according to manual. Plugging into head-unit does not work when the manual says to plug into monitor and vice versa.
Inserted picture totally wrong size or position.	Wrong monitor settings of video-interface.	Try different combinations of dips 7 and 8 of video-interface. Unplug 6pin power after each change.
Inserted picture double or 4 times on monitor.		
Inserted picture distorted, flickering or running vertically.	Video sources output set to AUTO or MULTI which causes a conflict with the interfaces auto detection.	Set video source output fixed to PAL or NTSC. It is best to set all video sources to the same standard.
	If error occurs only after source switching: Connected sources are not set to the same TV standard.	Set all video sources to the same standard.
	Some interfaces can only handle NTSC input.	Check manual whether there is a limitation to NTSC mentioned. If yes, set source fixed to NTSC output.
Inserted picture b/w.	Picture settings have not been adjusted.	Use the 3 buttons and the interface's OSD to adjust the picture settings for the corresponding video input.
Inserted picture qual. bad.		
Inserted picture size slightly wrong.		
Inserted picture position wrong.		
Camera input picture flickers.	Camera is being tested under fluorescent light which shines directly into the camera.	Test camera under natural light outside the garage.
Camera input picture is bluish.	Protection sticker not removed from camera lens.	Remove protection sticker from lens.

Symptom	Reason	Possible solution
Camera input picture black.	Camera power taken directly from reverse gear lamp.	Use relay or electronics to "clean" reverse gear lamp power. Alternatively, if CAN-bus box is compatible with the vehicle, camera power can be taken from green wire of 6pin to 8pin cable.
Camera input picture has distortion.		
Camera input picture settings cannot be adjusted.	Camera input picture settings can only be adjusted in AV2 mode.	Set dip 3 of video-interface to ON (if not input AV2 is not already activated) and connect the camera to AV2. Switch to AV2 and adjust settings. Reconnect camera to camera input and deactivate AV2 if not used for other source.
Graphics of a car in camera input picture.	Function PDC is ON in the interface OSD.	In compatible vehicles, the graphics will display the factory PDC distance. If not working or not wanted, set interface OSD menu item UI-CNTRL to ALLOFF.
Chinese signs in camera input picture	Function RET or ALL is ON (function for Asian market) in the interface OSD.	Set interface OSD menu item UI-CNTRL to ALLOFF or PDCON.
Not possible to switch video sources by OEM button.	CAN-bus interface does not support this function for vehicle.	Use external keypad or cut white wire of 6pin to 8pin cable and apply +12V impulses for AV-switching.
Not possible to switch video sources by external keypad.	Pressed too short.	For video source switching a longer press of about 2.5 seconds is required.
	SW-version of interface does not support external keypad.	Use OEM-button or cut white wire of 6pin to 8pin cable and apply +12V impulses for AV-switching.
Interface does not switch to camera input when reverse gear is engaged.	CAN-bus interface does not support this function for the vehicles.	Cut the green wire of the 6pin to 8pin cable and apply +12V constant from reverse gear-lamp signal. Use relay to "clean" R-gear lamp power.
Interface switches video-sources by itself.	CAN-bus interface compatibility to vehicle is limited.	Cut the grey wire of 6pin to 8pin and isolate both ends. If problem still occurs, additionally cut the white wire of 6pin to 8pin cable and isolate both ends.



10R-03 5384

Made in China

