



INSTALLATION MANUAL



Table of Contents

1. INTRODUCTION.....	2
2. RECOMMENDATIONS.....	2
3. LOCATION OF THE KIT COMPONENTS	4
4. CONNECTING ANTENNA	5
5. CONNECTION DIAGRAM CASE I.....	6
6. CONNECTION DIAGRAM CASE II.....	7
7. ADAPTATION PROCESS.....	9
8. BASIC TECHNICAL PARAMETERS.....	10
9. KIT COMPONENTS.....	10

1. INTRODUCTION

Digital DAB/DAB + radio tuner for the factory multimedia system MERCEDES COMAND NTG. The CI-DAB2T-NTG45 module enables playback digital DAB/DAB+ radio stations. The device is equipped with dual tuner (the second DAB tuner constantly searches for alternatives the frequency of the selected radio station; the station list is updated in this same time). In addition, the device has a tracking function selected station during the Service Following drive. It fully integrates with MOST optical system. Easy installation.

2. RECOMMENDATIONS

Copyright

All assembly and operating instructions are protected by copyright. Distributing documentation via print or online media is only allowed with the prior consent of JUNA electronics.

Important

Please read installation manual very careful and keep it in right way. During installation, pay attention to all relevant aspects related to safety of installation and use of the device.

The priority during the design and production of all devices by JUNA electronics company is security and service comfort. It has been achieved by applying the modern techniques of design and production processes of electronic devices.

Module should be installed in technical workshops by qualified personnel or by people who have experience in this type of installations. Installation of devices by not qualification people can cause injury to persons or damage to property.

It is recommended keep to the general safety rules and pay attention for any threat that can cause of damage to the vehicle.

We advice to mount device in safety place, where it is not exposed for moisture, water or too high temperatures.

2.2 RECOMMENDATIONS

Device should not be installed in places where it could difficult safe driving or operating efficiency of other units installed in vehicle.

The devices can be connected only to 12V. Modules can't be used in vehicles with 24V and higher voltage.

Please note that most of our devices are based on software that may require an update. That's why you should always mount the device in easily available place in the vehicle.

In some countries it may be necessary to check the legal provisions before installation and startup of the device. In the interest of high quality and development of our products, JUNA Electronics reserves the right to make technical changes.

In the case of a warranty claim, the device should be sent back to the seller in original packaging with a detailed description of the problem with attached purchase invoice.

Warranty claims as well as exploitation rights expire due:

- A) Not authorized changes in devices or accessories, which have not been approved or have not been provided by the manufacturer or his partners.
- B) Opening the device's box
- C) Yourself repair the device
- D) Improper use / improper operation of the device
- E) Mechanical damage
- F) Flooding with water or other liquids

3. LOCATION OF THE KIT COMPONENTS

The correct location of the CI-DAB2T-NTG45 components in Mercedes.

1. Connection point for the JRDAB-03 radio module for: MERCEDES C, MERCEDES E (c207, a207), MERCEDES GLK, MERCEDES SL, MERCEDES SLK, MERCEDES SLC,
2. Connection point for the JRDAB-03 radio module for: MERCEDES CL, MERCEDES CLS, MERCEDES E (s211, w211, s212, w212, v212), Mercedes G, MERCEDES R, MERCEDES S,
3. Connection point for the JRDAB-03 radio module for: MERCEDES A, MERCEDES B, MERCEDES CLA, MERCEDES GLA,
4. Connection place for the JRDAB-03 radio module for MERCEDES GL, MERCEDES GLS, MERCEDES ML, MERCEDES GLE,
5. Place of mounting the antenna from the set (as an option if not used factory antenna).

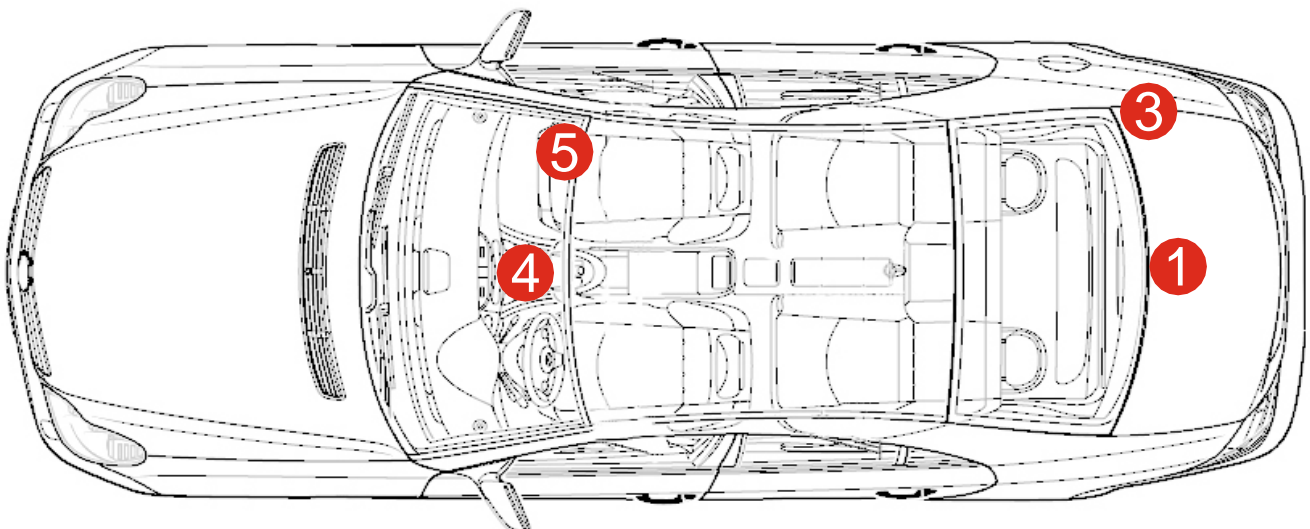
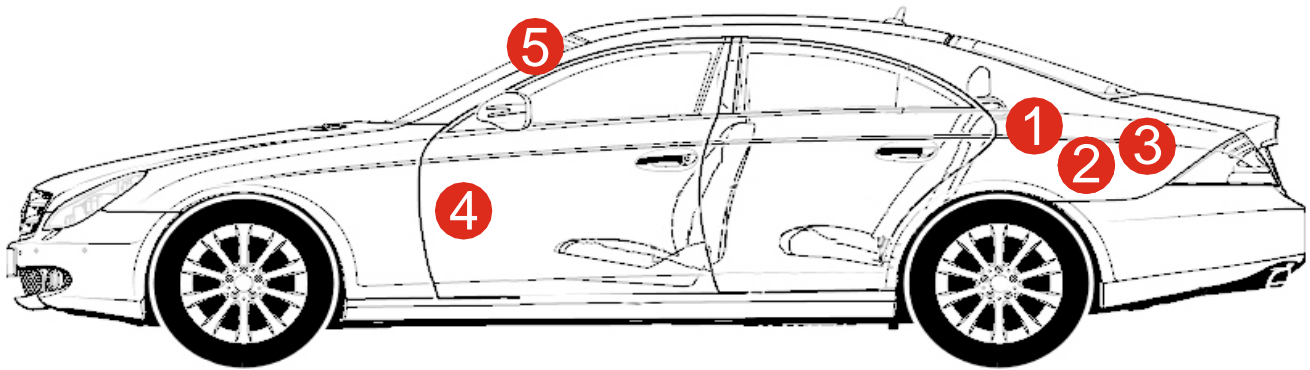

Pic.1

4. ANTENNA CONNECTION

The device in addition to the possibility of connecting the DAB/DAB+ antenna included in the set, allow to connect the factory antenna set which includes the factory antenna with the antenna amplifier mounted most often on the tailgate of the luggage compartment. The amplifier is powered from the JRDAB-03 module with 12 voltage.

Important:

During installation antenna cable along the the body pillar it is necessary to pay attention for side airbags. Cable must be installed in way to not disturb the proper operation of the air curtain.

Installation process:

- 1) Installation of antenna is not recommended when windscreen is very cold
- 2) Antenna should be mounted on windscreen from passenger side
- 3) Carefully remove the passenger side pistol cover
- 4) Clean a place where antenna will be mounted
- 5) Antenna should be mounted 15 cm from top edge and 7 cm from side edge of windscreen
- 6) Ground element of antenna amplifier should touch metal part of post. It can be join to factory painted part of pistol
- 7) Antenna cable should be mounted in way to not interference with side airbag



Example of mounting a DAB/DAB+ antenna

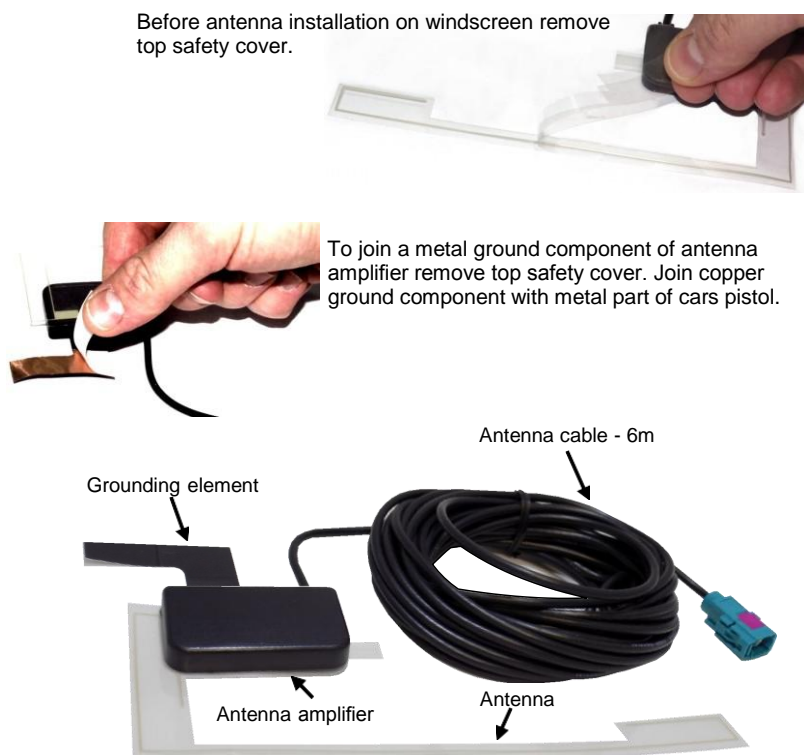

Antenna DAB/DAB+

Pic.2

5. CONNECTION DIAGRAM - CASE I

Connection diagram of JRDAB-03 with multimedia unit Mercedes Benz NTG for cars equipped with modules connected to fiber optic bus MOST.

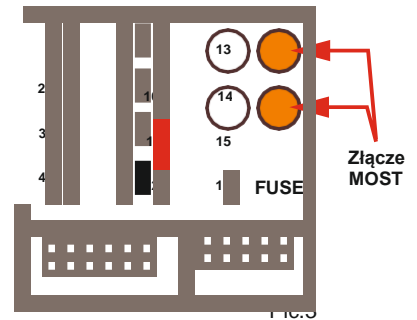

Information: We recommend to connect supply wires to QUADLOCK socket - pin 12 ground and pin 15 (+12V). The connection must be electrically durable, preferably soldered and properly insulated. We do not recommend crimp connections.

1. Turn the ignition and NTG Command system off
2. Take the NTG Command system out from middle panel
3. Disconnect QUADLOCK connector from NTG Command unit
4. Unplug factory fiber optic connector from QUADLOCK connector **1**
5. Plug the K-SW102MR connector to QUADLOCK **2**
6. Connect QUADLOCK connector to NTG Command unit **3**
7. Connect K-SW102MR connector to JRDAB-03 module socket **4**
8. Connect W-ZAZ101a connector to JRDAB-03 module socket **5**
9. Connect FAKRA connector to JRDAB-03 module antenna socket **6**
10. Connect supply wires from W-ZS101a to QUADLOCK (Pic.3)
11. Plug the header from set to socket in fiber optic cable K-SW102MR **7**
12. Unplugged factory fiber optic connector connect to socket of K-SW102MR splitter using the header included in set **8**
13. Install Command NTG unit in middle panel
14. Turn the ignition on and start the unit in car
15. Run module adaptation process to system

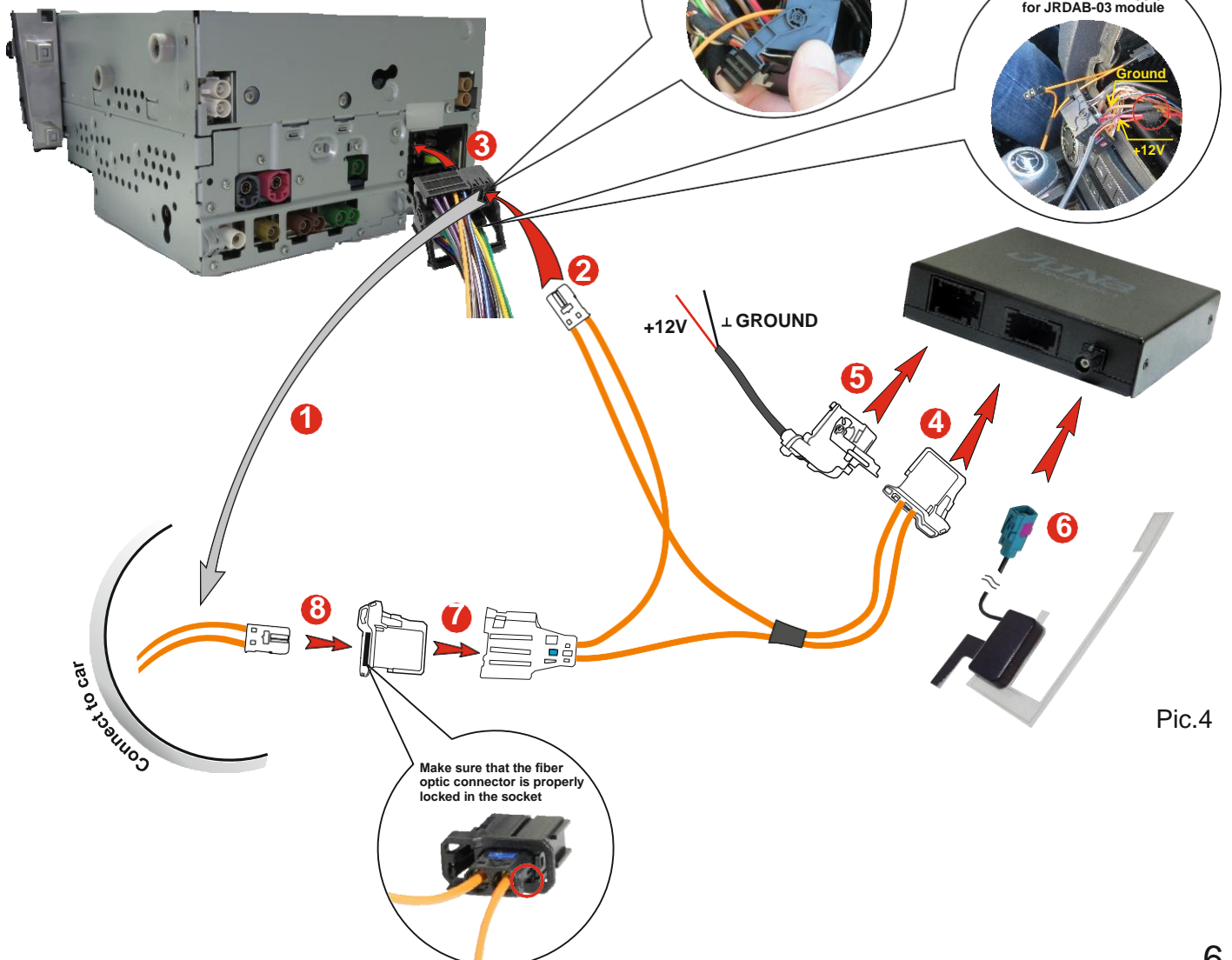

Pic.4

6. CONNECTION DIAGRAM - CASE II

Connection diagram of JRDAB-03 with multimedia unit Mercedes Benz NTG for cars not equipped with modules connected to fiber optic bus MOST.

1. Turn the ignition and NTG Command system off
2. Take the NTG Command system out from middle panel
3. Disconnect QUADLOCK connector from NTG Command unit
4. Plug the K-SW102MR connector to QUADLOCK ①
5. Connect QUADLOCK connector to NTG Command unit ②
6. Connect K-SW102MR connector to JRDAB-03 module socket ③
7. Connect W-ZAZ101a connector to JRDAB-03 module socket ④
8. Connect FAKRA connector to JRDAB-03 module antenna socket ⑤
9. Connect supply wires from W-ZS101a to QUADLOCK (Pic.5)
10. Plug the header from set to socket in fiber optic cable K-SW102MR
11. Install Command NTG unit in middle panel
12. Turn the ignition on and start the unit in car
13. Run module adaptation process to system

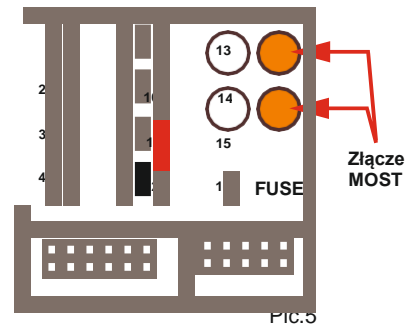

Information: We recommend to connect supply wires to QUADLOCK socket - pin 12 ground and pin 15 (+12V). The connection must be electrically durable, preferably soldered and properly insulated. We do not recommend crimp connections.

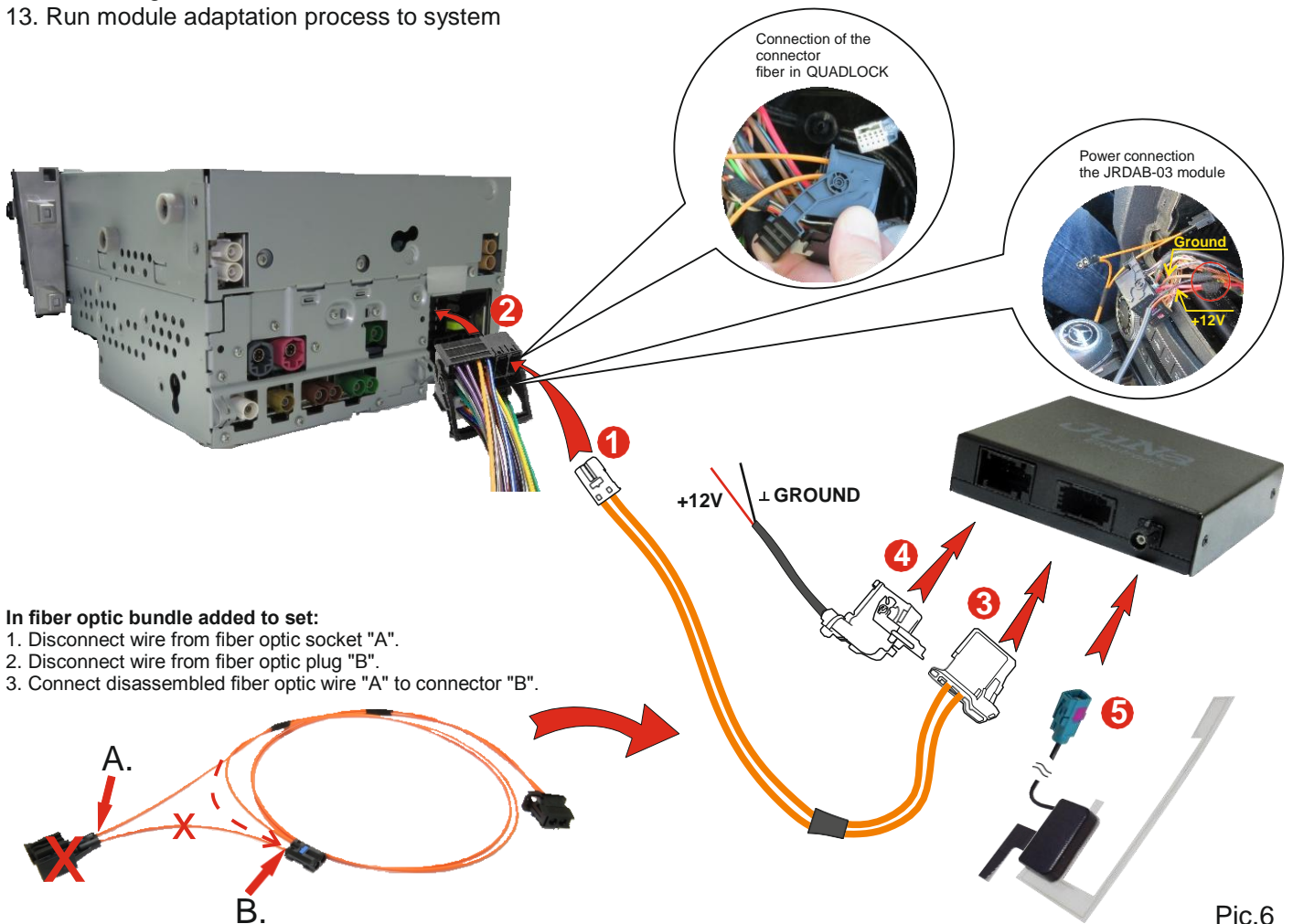

In fiber optic bundle added to set:

1. Disconnect wire from fiber optic socket "A".
2. Disconnect wire from fiber optic plug "B".
3. Connect disassembled fiber optic wire "A" to connector "B".

Information:

Detailed diagram of preparation fiber optic bundle MOST is on page 8. →

Diagram of preparation fiber optic connection of JRDAB-03 module with Mercedes Command unit NTG for cars not equipped with modules connected to fiber optic bus MOST. The following is a method of adapting the optical fiber attached to the kit. Fiber optic bundle included in the kit.

Fiber optic bundle included in the kit.

Target fiber optic bundle after adaptation.

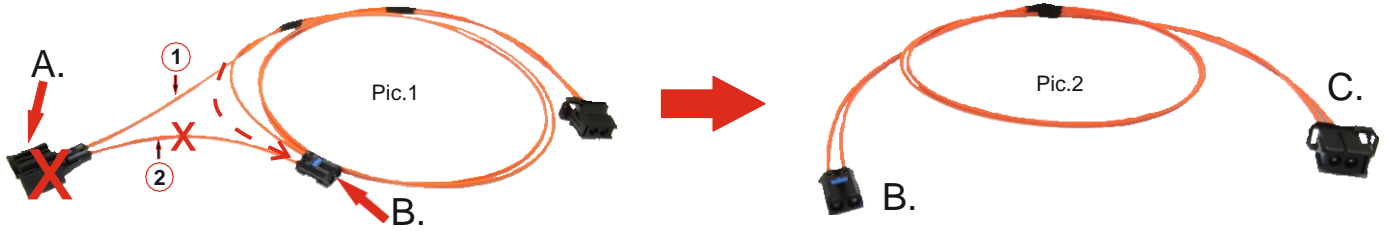

For fiber bundle adaptation it is necessary to disassemble socket „A” and fiber optic wire ② then unplug fiber optic wire ① from socket „A” and install it in plug „B” in place of removed fiber optic wire ② Pic.1

Disassembly of socket „A” and disconnection of optical fiber ① Pic.1.

1. We remove the blue cable protector in the socket „A” by pressing it with the thin tool.

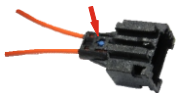

2. Pull out the blue lock from the „A” fiber optic socket.

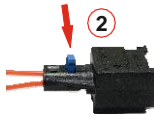

3. We unlock another security by, for example, a small screwdriver, a lock of the fiber optic cable from the „A” socket. ①



Disassembly of socket „B” and take out of fiber optic wire ② Pic.1

4. Pull out the blue lock from the fiber optic plug „B”.

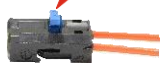

5. We unlock another security by, for example, a small screwdriver, a lock of the fiber optic cable from the „B” plug ②



6. Disconnect the fiber optic cable from ② the „B” plug and insert the fiber optic cable ① in its place Assembly of socket „B”.



Assembly of socket „B”.

7. Insert blue lock to „B” socket.

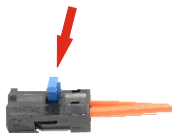

8. Properly assembled fiber optic connector.





9. Fiber optic cable for connecting the JRDAB-03 radio module in a cars not equipped with modules connected to fiber optic bus MOST.



Pic.7

7. ADAPTATION PROCESS

To run adaptation process of JRDAB module it is necessary to start service menu by holding

together buttons:  +  +  for 5 seconds on Command NTG unit.

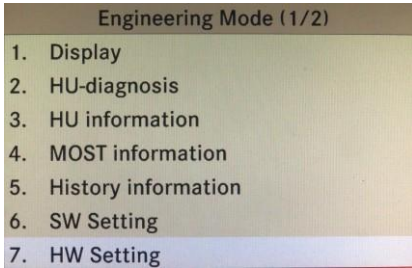

1. Select HW Settings option.

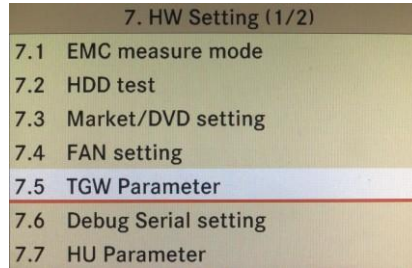

2. Select TGW parameter option.

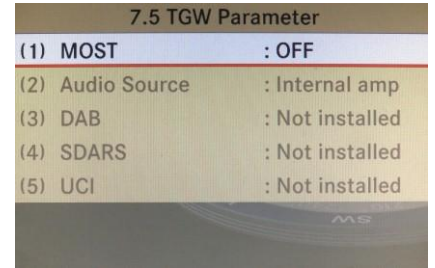

3. Set MOST and DAB parameters in TGW Parameter.

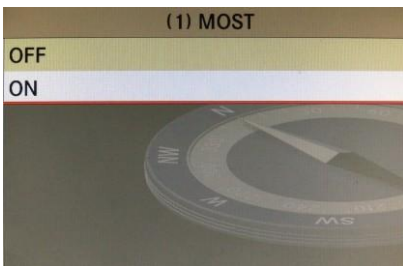

4. In settings of MOST parameter choose **ON** option.

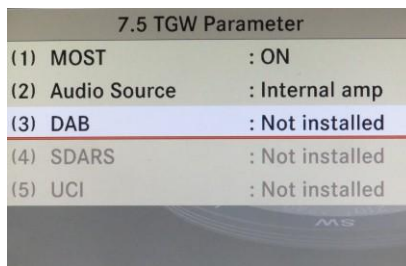

5. Settings of DAB parameter.

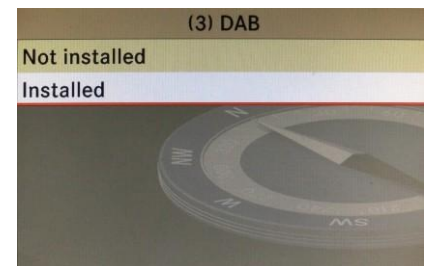

6. In settings of DAB parameter choose installed option.

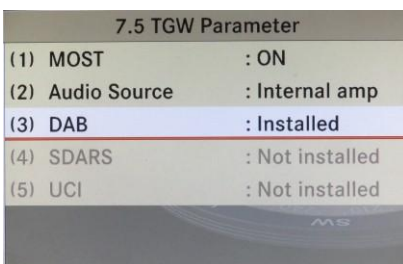

7. Proper sets of adaptation parameters for JRDAB.

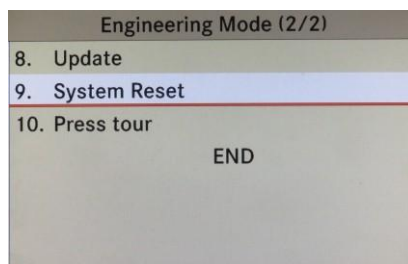

8. After the module adaptation process it is necessary to find system reset option.

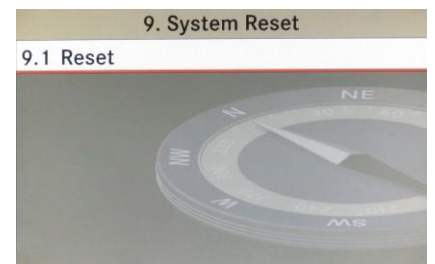

9. Choose the reset option of NTG Command unit.

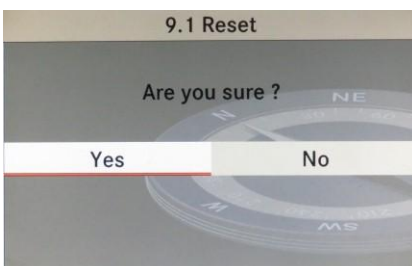

10. Commit the restart of NTG Command.

Attention:

If the JRDAB-03 module is installed in NTG 2.5 and NTG 3 units, it will probably be necessary to use specialized software, e.g. Vediamo.

8. BASIC TECHNICAL PARAMETERS

- | | |
|------------------------------|------------------------|
| 1. Supply voltage | - 12V (+10,5V - 14,8V) |
| 2. Communication and control | - Magistrala MOST |
| 3. Box | - Metal |
| 4. Size | - 105mm x 90mm x 25mm |
| 5. Weight | - 255g |

9. KIT COMPONENTS

1. DAB/DAB+ radio module [JRDAB-03]
2. Supply bundle [W-ZAS101A]
3. Fiber optic bundle [K-SW102MR]
4. Antenna [TLG7205]



Pic.8